

HDCVI PRODUCT SELECTION

2018 Ver. 2

HDCVI Cameras / PTZ / Recorders / Accessories / Video Management Software / DORI Distance



CONTENTS



07

HDCVI CAMERAS

Ultra Series / Pro Series / Lite Series / IoT Series

27

HDCVI PTZ CAMERAS

Ultra Series / Pro Series / Lite Series



34

HDCVI RECORDERS

Pro Series / Lite Series

44

NETWORK VIDEO SERVERS

Network Video Servers

45

ACCESSORIES / DISPLAY & CONTROL /
VIDEO MANAGEMENT SOFTWARE /
DORI DISTANCE(D/O/R/I)



HDCVI TECHNOLOGY

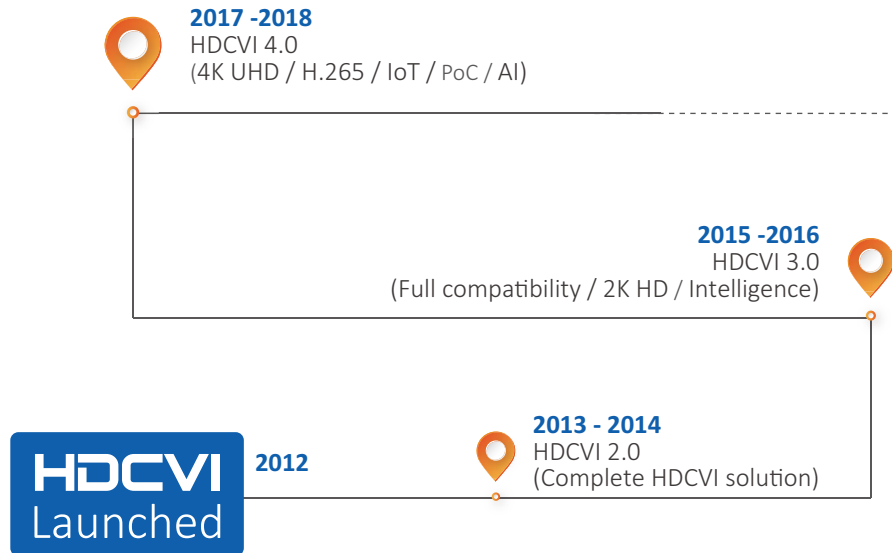

In 2012, Dahua led the industry in launching HDCVI Technology and continues to enhance its technology leadership by bringing state of the art performance in terms of resolution, light sensitivity, intelligence, and usability to the HDCVI community. With a mission of “Enabling a safer society and smarter living”, Dahua will keep on providing more opportunities to customers as well as improve its services with innovations and technological advancements.

“ HDCVI is an over-coaxial cable video transmission standard that provides reliable long-distance HD video transmission for a wide range of application scenarios at a friendly cost. Here are the main benefits of HDCVI: ”



4 Signals

Video/Audio/Data/Power over one cable



Long Distance

Long distance transmission:
Coaxial Cable: Up to 1200m
UTP: Up to 450m



High Resolution

4K/6MP/4MP
1080P/720P



Seamless Upgrade

Compatible with existing coaxial cable, protecting your investment.
Penta-brid (HDCVR/AHD/TVI/CVBS/IP)
Seamless upgrade from traditional analog systems;

4K Ultra High Definition

4K features 4 times the resolution of 1080P. Therefore, 4K products present images with impressive clarity and abundant details. As the first technology to release 4K-over-coax, HDCVI again leads the industry with a new and complete 4K product series which better fits the needs of various application and projects with different scales and budgets, enabling 4K to prevail in the market.



Provides crystal-clear details even during digital zoom with 4x pixels more than 2MP video surveillance.

Starlight+

Performance under low illumination is a common challenge faced by the surveillance industry. The HDCVI 4K series adopts an up to 4/3" large sensor and advanced image processing technology to ensure high performance even under ultra-low light conditions.

- Large aperture combined with big pixel size (4.63μm) ensures Starlight+ performance.
- Excellent full color image quality even under low illumination.



Non-Starlight

Starlight

Starlight+

H.265+

HDCVI-H.265+ technology, an intelligent video compression algorithm developed by Dahua, has been released with the goal of broadening the application scope of 4K/4MP UHD devices in the video surveillance industry. HDCVI-H.265+ smart codec can save up to 90% on bandwidth and video storage usage while ensuring high image quality.



Advanced Bit Rate Control

Scene adaptive encoding strategy

Video Encoding Based on Video Content Analytics

Dynamic ROI & dynamic GOP
Flexible reference frame structure

Noise Suppression Technology

Adopts various noise reduction levels

24 Hour Testing

In a day of testing, HDCVI-H.265+ saved up to 90% storage space on average compared with H.264.

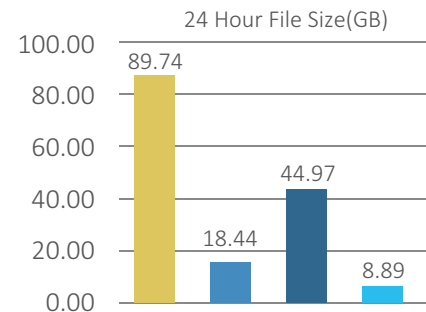

Up to 90% Savings!

- H.264+
- H.264
- H.265+
- H.265

Testing environment

Resolution : 4K@15fps
Scenario : Outdoor
Test time : 24 hour

Panorama

The new HDCVI 4K series offers panoramic cameras to be used over existing coaxial cable infrastructure for the first time ever, enabling a cost-effective solution for large area surveillance with a simple upgrade from legacy infrastructure.

- Multi-sensor model offers 180° panoramic view & simultaneous 3x2MP images.



Panorama

- 8MP Fisheye with 360° panoramic view and 10 dewarping modes on XVR or VMS is the perfect choice for large area surveillance.



Original Fisheye Image

Camera Lens Distortion Correction

Brand New GUI-XVR4.0

After over a year of design and development, the next generation GUI interface, XVR4.0, will be released together with HDCVI-H.265 products. Beautiful and simple, XVR4.0 ensures perfect display.

- Color schemes, flat interface, and visual icons present a user-friendly experience
- Integrated functional modules and logic to simplify user operation and enhance product competitiveness

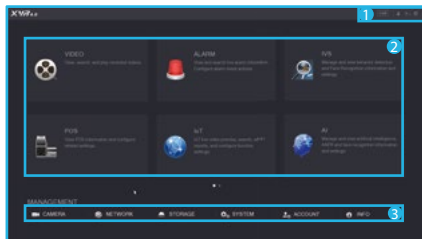

1 Navigation bar

Live view, User, Logout, QR code.

2 Business module

Video, Alarm, IVS, etc.
Supports page turning

3 Management module

Camera, Network, System, and other settings

IoT

HDCVI-IoT is a comprehensive system linking HDCVI video, audio and data with sensor info such as temperature, humidity, and alarms to warn potential risks and to provide alarm visual verifications.

Simple HDCVI-IoT system diagram:

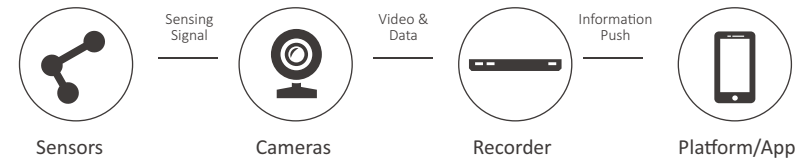

- Collects temperature & humidity info to enhance process efficiency
- Integrates wireless sensors to sound alarm in real time
- Alarm visual verification with HDCVI video, audio and data
- Accurate intrusion detection based on both PIR & motion
- XVR with centralized IoT management, data reports and friendly UI
- Easy HDCVI system deployment saves costs

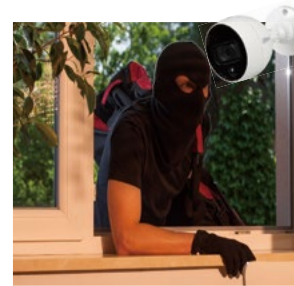

Visual alarm verification

The capture of negligible movements occupies storage space, and can result in overreactions and waste of labor and resources. Video & PIR Dual-detect can improve the accuracy of motion detection triggering which plays an auxiliary role to filter false alarms caused by indifferent objects and saves the video storage.



Integrate video with sensor info

With HDCVI-IoT, a climate-controlled warehouse is able to prevent theft while monitoring storage conditions, and alerts about events like sudden intrusion or rising temperature are all accompanied with video for verification. Warehouses already equipped with analog systems can be easily upgraded to HDCVI-IoT at little cost.

POS 2.0

The H.265 XVR series integrates POS (Point of Sale) functionality with video to record business information, identify problems, and provide evidence for disputes for retail applications. Video and corresponding POS information can be shown simultaneously in both live and playback mode. The system also supports accurate search and fuzzy search to find bills and associated recordings.



POS Integration at XVR

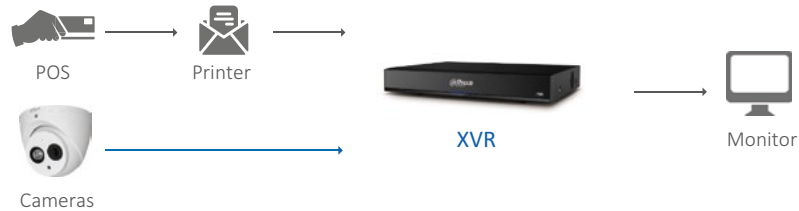

PoC

PoC (Power over Coax) transmits both video and electrical power over a single coaxial cable. HDCVI PoC technology further simplifies HDCVI system deployment, reducing time and cost. Long distance transmission capability guarantees up to 400m for 1080P and 300m for 4MP transmission.

Conventional System:

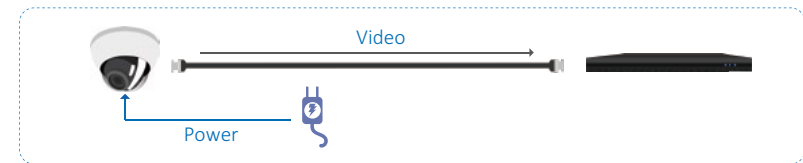

PoC System:

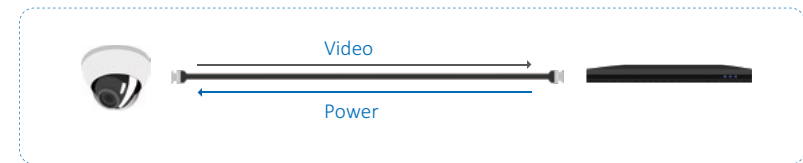

Broadcast-quality Audio



Audio info supplies supplementary evidence to video surveillance, and can be used to settle disputes. In applications where conflicts occur, such as checkout counters, loud and clear audio can be useful to uncover reasons for the event. HDCVI offers multiple models supporting audio-in interface or built-in mic. Taking advantage of innovative lossless audio-over-coax transmission technology and advanced noise reduction algorithms, HDCVI is now able to provide users an enjoyable experience with newly released broadcast-quality audio.

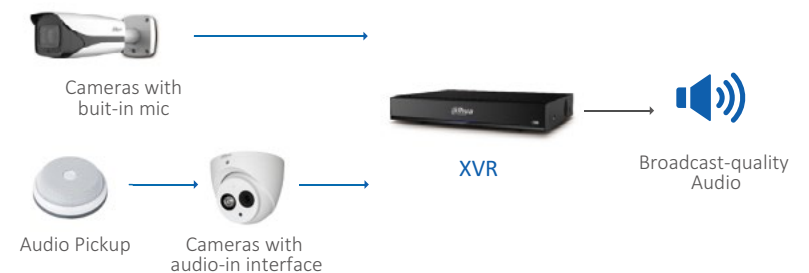

*All Fighter series cameras are equipped with audio-in interface, which can connect to pickup. Built-in mic is also supported on select models.

HDCVI CAMERAS



Ultra Series

The Ultra Series is an ideal option for surveillance professionals committed to introducing top-level performance into coaxial systems. HDCVI 4K cameras are the first in the industry to enable 4K resolution over coaxial cable. In addition, multi-lens and fisheye cameras allow for the replacement of multiple cameras, greatly simplifying system installation and maintenance.

⊕ KEY FEATURES

High Resolution

Up to 4K resolution ensures high image quality

Superior Image

Starlight / Ultra 140dB WDR provides clear image under extreme light conditions

Wide Selection





Multi-lens and fisheye cameras can replace multiple cameras, saving on costs

Project-oriented

Audio-in, alarm in/out interfaces and IP67/IK10 protection to better meets project requirements.

Ultra Series

4K Starlight

Model	HAC-HF3805G	HAC-HFW3802E-Z/ZH-VP	HAC-HDBW3802E-Z/ZH	HAC-EBW3802
Appearance	 Starlight	 Starlight	 Starlight	 Starlight
Image Sensor	4/3" 8MP STARVIS™ CMOS	1/2" 8MP CMOS	1/2" 8MP CMOS	1/2" 8MP CMOS
Min. Illumination	0.001Lux/F1.2 (Color)	0.005Lux/F1.5 (Color) 0Lux/F1.5 (IR On)	0.005Lux/F1.5 (Color) 0Lux/F1.5 (IR On)	0.005Lux/F2.0 (Color) 0Lux/F2.0 (IR On)
Lens	M43, Auto Iris	3.7~11mm Motorized, Auto Iris	3.7~11mm Motorized, Auto Iris	2.5mm
FOV-H	-	112°~46°	112°~46°	180°
Day/Night	Color	ICR	ICR	ICR
Max. IR Distance	-	100m (328ft), Smart IR	50m (164ft), Smart IR	15m (49ft), Smart IR
OSD Menu	Multi-language	Multi-language	Multi-language	Multi-language
WDR	140dB	120dB	120dB	120dB
Noise Reduction	2D/3D	2D/3D	2D/3D	2D/3D
Frame Rate	HDMI: 30fps@4K, 30fps@4MP BNC: 15fps@4K, 30fps@4MP	15fps@4K, 30fps@4MP	15fps@4K, 30fps@4MP	15fps@4K, 30fps@4MP
Video Output	HD (HDMI & BNC Output)	HD/SD Dual-output SD Tester-out	HD/SD Dual-output SD Tester-out	HD/SD Dual-output
Audio In	1ch in & Built-in Mic	1	1	1ch in & Built-in Mic
Alarm In/Out	2/1	2/1	2/1	2/1
Pan/Tilt/Rotation	-	Pan: 0°~360°; Tilt: 0°~90° Rotation: 0°~360°	Pan: 0°~355°; Tilt: 0°~85° Rotation: 0°~355°	-
Ingress Protection	-	IP67, IK10	IP67, IK10	IP67, IK10
Working Temperature	-30°C~+60°C (-22°F ~ +140°F)	-30°C~+60°C (-22°F ~ +140°F)(Z) -40°C~+60°C (-40°F ~ +140°F)(ZH)	-30°C~+60°C (-22°F ~ +140°F)(Z) -40°C~+60°C (-40°F ~ +140°F)(ZH)	-30°C~+60°C (-22°F ~ +140°F)
Power	AC24V±25%/DC12V±25% Max. 6.4W	AC24V±25%/DC12V±25% Max. 18.4W Output: DC12V, Max. 4W	AC24V±25%/DC12V±25% Max. 12.4W Output: DC12V, Max. 4W	DC12V±25% Max. 7.4W

HDCVI CAMERAS

Ultra Series

	Multi-sensor	1080P Starlight				Pinhole
Model	HAC-PFW3601-A180	HAC-HF3231E(-T)	HAC-HFW3231E-Z12	HAC-HFW3231E-Z(T)/ZH	HAC-HDBW3231E-Z(T)/ZH	HAC-HUM3201B
Appearance	 Starlight	 Starlight	 Starlight	 Starlight	 Starlight	 Starlight
Image Sensor	3×1/2.8" 2MP STARVIS™ CMOS	1/2.8" 2MP STARVIS™ CMOS	1/2.8" 2MP STARVIS™ CMOS	1/2.8" 2MP STARVIS™ CMOS	1/2.8" 2MP STARVIS™ CMOS	1/2.8" 2MP STARVIS™ CMOS
Min. Illumination	0.005Lux/F1.8 (Color) 0Lux/F1.8 (IR On)	0.005Lux/F1.2 (Color) 0.0005Lux/F1.2 (B/W)	0.005Lux/F1.6 (Color) 0Lux/F1.6 (IR On)	0.005Lux/F1.4 (Color) 0Lux/F1.4 (IR On)	0.005Lux/F1.4 (Color) 0Lux/F1.4 (IR On)	0.005Lux/F2.4 (Color) 0.0005Lux/F2.4 (B/W)
Lens	3×3.6mm	C/CS, Auto Iris	5.3~64mm Motorized, Auto Iris	2.7~12mm Motorized, Auto Iris	2.7~12mm Motorized, Auto Iris	3.6mm (2.8mm Optional)
FOV-H	Panoramic View: 180° Single View: 3×87°	-	58°~5°	95°~36°	95°~36°	92°(103°)
Day/Night	ICR	ICR	ICR	ICR	ICR	Electronic
Max. IR Distance	20m (66ft), Smart IR	-	100m (328ft), Smart IR	100m (328ft), Smart IR	50m (164ft), Smart IR	-
OSD Menu	Multi-language	Multi-language	Multi-language	Multi-language	Multi-language	Multi-language
WDR	120dB	120dB	120dB	120dB	120dB	120dB
Noise Reduction	2D/3D	2D/3D	2D/3D	2D/3D	2D/3D	2D/3D
Frame Rate	Panoramic View: 15fps@4K, 25fps@4MP Single View: 25fps@1080P	30fps@1080P 30/60fps@720P	30fps@1080P 30/60fps@720P	30fps@1080P 30/60fps@720P	30fps@1080P 30/60fps@720P	30fps@1080P 30fps@720P
Video Output	HD (1×Panoramic View & 3×Single View Output) SD Tester-out (Panoramic View)	HD/SD Dual-output SDI Output(-T)	HD/SD Dual-output SD Tester-out	HD/SD Dual-output SD Tester-out, SDI Output(-ZT)	HD/SD Dual-output SD Tester-out, SDI Output(-ZT)	HD/SD Switchable
Audio In	1	1ch in & Built-in Mic	1	1	1	-
Alarm In/Out	2/1	2/1	2/1	1/1	1/1	-
Pan/Tilt/Rotation	Pan: 0°~360°; Tilt: 0°~90° Rotation: 0°~360°	-	Pan: 0°~360°; Tilt: 0°~90° Rotation: 0°~360°	Pan: 0°~360°; Tilt: 0°~90° Rotation: 0°~360°	Pan: 0°~355°; Tilt: 0°~85° Rotation: 0°~355°	Pan: 0°~360°; Tilt: 0°~180° Rotation: NA
Ingress Protection	IP67, IK10	-	IP67, IK10	IP67, IK10	IP67, IK10	-
Working Temperature	-30°C~+60°C (-22°F~+140°F)	-30°C~+60°C (-22°F~+140°F)	-30°C~+60°C (-22°F~+140°F)	-30°C~+60°C (-22°F~+140°F)(Z/ZT) -40°C~+60°C (-40°F~+140°F)(ZH)	-30°C~+60°C (-22°F~+140°F)(Z/ZT) -40°C~+60°C (-40°F~+140°F)(ZH)	-40°C~+60°C (-40°F~+140°F)
Power	DC12V±25%, Max. 22W (AC24V±25% Optional, Max. 22W)	AC24V±25%/DC12V±25% Max. 4.7W	AC24V±25%/DC12V±25% Max. 15.6W	AC24V±25%/DC12V±25% Max. 16.6W	AC24V±25%/DC12V±25% Max. 12.5W	DC12V±25% Max. 1.2W

Pro Series

The Pro Series is a perfect choice for mid to large-scale businesses and projects where both high reliability and flexibility are required. The Pro Series provides various motorized/fixed lens models for both indoor and outdoor applications. All cameras are built to provide a high quality image with clear details and accurate colors.

⊕ KEY FEATURES

Optimized Image

Starlight / 120dB WDR provides clear image under tough light conditions

High Definition

Up to 4K/6MP resolution presents more details

Wide Selection





10+ fixed / motorized lens models available to fit any scenario

Audio

In-house ISP "Fighter" delivers superior high quality audio to collect supplementary evidence







Pro Series

4K Starlight

Model	HAC-HFW2802T-Z-A(-DP)	HAC-HDBW2802R-Z(-DP)	HAC-HDW2802T-Z-A(-DP)	HAC-HFW2802T-I8-A	HAC-HFW2802E-A
Appearance	 Starlight Fighter	 Starlight Fighter	 Starlight Fighter	 Starlight Fighter	 Starlight Fighter
Image Sensor	1/2" 8MP CMOS	1/2" 8MP CMOS	1/2" 8MP CMOS	1/2" 8MP CMOS	1/2" 8MP CMOS
Min. Illumination	0.005Lux/F1.5(Color) 0Lux/F1.5(IR on)	0.005Lux/F1.5(Color) 0Lux/F1.5(IR on)	0.005Lux/F1.5(Color) 0Lux/F1.5(IR on)	0.005Lux/F1.6(Color) 0Lux/F1.6(IR on)	0.005Lux/F1.6(Color) 0Lux/F1.6(IR on)
Lens	3.7-11mm, Motorized	3.7-11mm, Motorized	3.7-11mm, Motorized	3.6mm (6mm Optional)	3.6mm (2.8mm, 6mm Optional)
FOV-H	112°~46°	112°~46°	112°~46°	87°(55°)	87°(110.8°/55°)
Day/Night	ICR	ICR	ICR	ICR	ICR
Max. IR Distance	80m (262ft), Smart IR	30m (98ft), Smart IR	60m (197ft), Smart IR	80m (262ft), Smart IR	40m (131ft), Smart IR
OSD Menu	Multi-language	Multi-language	Multi-language	Multi-language	Multi-language
WDR	120dB	120dB	120dB	120dB	120dB
Noise Reduction	2D/3D	2D/3D	2D/3D	2D/3D	2D/3D
Frame Rate	15fps@4K, 20fps@6MP 30fps@4MP	15fps@4K, 20fps@6MP 30fps@4MP	15fps@4K, 20fps@6MP 30fps@4MP	15fps@4K, 20fps@6MP 30fps@4MP	15fps@4K, 20fps@6MP 30fps@4MP
Video Output	HD/SD Switchable	HD/SD Switchable	HD/SD Switchable	HD/SD Switchable	HD/SD Switchable
Audio In	1ch in & Built-in Mic	1	1ch in & Built-in Mic	1ch in & Built-in Mic	1ch in & Built-in Mic
Alarm In/Out	-	-	-	-	-
Pan/Tilt/Rotation	Pan: 0°~360°; Tilt: 0°~90° Rotation: 0°~360°	Pan: 0°~355°; Tilt: 0°~75° Rotation: 0°~355°	Pan: 0°~360°; Tilt: 0°~78° Rotation: 0°~360°	Pan: 0°~360°; Tilt: 0°~90° Rotation: 0°~360°	Pan: 0°~360°; Tilt: 0°~90° Rotation: 0°~360°
Ingress Protection	IP67	IP67, IK10	IP67	IP67	IP67
Working Temperature	-30°C~+60°C (-22°F~+140°F)	-30°C~+60°C (-22°F~+140°F)	-30°C~+60°C (-22°F~+140°F)	-30°C~+60°C (-22°F~+140°F)	-30°C~+60°C (-22°F~+140°F)
Power	DC12V±30%, Max. 12.5W DC 12V±30%/AC 24V±30% Max. 15W(-DP) Output: DC12V, Max. 2W(-DP)	DC12V±30%, Max. 7W DC 12V±30%/AC 24V±30% Max. 8.4W(-DP) Output: DC12V, Max. 2W(-DP)	DC12V±30%, Max. 9.5W DC 12V±30%/AC 24V±30% Max. 12W(-DP) Output: DC12V, Max. 2W(-DP)	DC12V±30% Max. 11.3W	DC12V±30% Max. 6.8W





HDCVI CAMERAS

Pro Series

	4K Starlight		6MP				
Model	HAC-HDBW2802R	HAC-HDW2802T-A	HAC-HFW2601T-Z-A(-DP)	HAC-HDBW2601R-Z(-DP)	HAC-HDW2601T-Z-A(-DP)	HAC-HFW2601E-A	HAC-HDW2601T-A
Appearance	 Starlight Fighter	 Starlight Fighter	 Fighter	 Fighter	 Fighter	 Fighter	 Fighter
Image Sensor	1/2" 8MP CMOS	1/2" 8MP CMOS	1/2.9" 6MP CMOS	1/2.9" 6MP CMOS	1/2.9" 6MP CMOS	1/2.9" 6MP CMOS	1/2.9" 6MP CMOS
Min. Illumination	0.005Lux/F1.6(Color) 0Lux/F1.6(IR on)	0.005Lux/F1.6(Color) 0Lux/F1.6(IR on)	0.01Lux/F1.6(Color) 0Lux/F1.6(IR on)	0.01Lux/F1.6(Color) 0Lux/F1.6(IR on)	0.01Lux/F1.6(Color) 0Lux/F1.6(IR on)	0.01Lux/F1.9(Color) 0Lux/F1.9(IR on)	0.01Lux/F1.9(Color) 0Lux/F1.9(IR on)
Lens	3.6mm (2.8mm Optional)	3.6mm (2.8mm, 6mm Optional)	2.7-13.5mm, Motorized	2.7-13.5mm, Motorized	2.7-13.5mm, Motorized	3.6mm (2.8mm, 6mm Optional)	3.6mm (2.8mm, 6mm Optional)
FOV-H	87°(110.8°)	87°(110.8°/55°)	95.1°~25.7°	95.1°~25.7°	95.1°~25.7°	70°(96°/47.3°)	70°(96°/47.3°)
Day/Night	ICR	ICR	ICR	ICR	ICR	ICR	ICR
Max. IR Distance	30m (98ft), Smart IR	50m (164ft), Smart IR	80m (262ft), Smart IR	30m (98ft), Smart IR	60m (197ft), Smart IR	40m (131ft), Smart IR	50m (164ft), Smart IR
OSD Menu	Multi-language	Multi-language	Multi-language	Multi-language	Multi-language	Multi-language	Multi-language
WDR	120dB	120dB	120dB	120dB	120dB	120dB	120dB
Noise Reduction	2D/3D	2D/3D	2D/3D	2D/3D	2D/3D	2D/3D	2D/3D
Frame Rate	15fps@4K, 20fps@6MP 30fps@4MP	15fps@4K, 20fps@6MP 30fps@4MP	20fps@6MP, 30fps@4MP	20fps@6MP, 30fps@4MP	20fps@6MP, 30fps@4MP	20fps@6MP, 30fps@4MP	20fps@6MP, 30fps@4MP
Video Output	HD/SD Switchable	HD/SD Switchable	HD/SD Switchable	HD/SD Switchable	HD/SD Switchable	HD/SD Switchable	HD/SD Switchable
Audio In	1	1ch in & Built-in Mic	1ch in & Built-in Mic	1	1ch in & Built-in Mic	1ch in & Built-in Mic	1ch in & Built-in Mic
Alarm In/Out	-	-	-	-	-	-	-
Pan/Tilt/Rotation	Pan: 0°~355°; Tilt: 0°~75° Rotation: 0°~355°	Pan: 0°~360°; Tilt: 0°~78° Rotation: 0°~360°	Pan: 0°~360°; Tilt: 0°~90° Rotation: 0°~360°	Pan: 0°~355°; Tilt: 0°~75° Rotation: 0°~355°	Pan: 0°~360°; Tilt: 0°~78° Rotation: 0°~360°	Pan: 0°~360°; Tilt: 0°~90° Rotation: 0°~360°	Pan: 0°~360°; Tilt: 0°~78° Rotation: 0°~360°
Ingress Protection	IP67, IK10	IP67	IP67	IP67, IK10	IP67	IP67	IP67
Working Temperature	-30°C~+60°C (-22°F~+140°F)	-30°C~+60°C (-22°F~+140°F)	-30°C~+60°C (-22°F~+140°F)	-30°C~+60°C (-22°F~+140°F)	-30°C~+60°C (-22°F~+140°F)	-30°C~+60°C (-22°F~+140°F)	-30°C~+60°C (-22°F~+140°F)
Power	DC12V±30% Max. 7W	DC12V±30% Max. 8W	DC12V±30%, Max. 12W DC 12V±30%/AC24V±30% Max. 15W(-DP) Output: DC12V, Max. 2W(-DP)	DC12V±30%, Max. 6.8W DC 12V±30%/AC24V±30% Max. 8.4W(-DP) Output: DC12V, Max. 2W(-DP)	DC12V±30%, Max. 9W DC 12V±30%/AC24V±30% Max. 11.5W(-DP) Output: DC12V, Max. 2W(-DP)	DC12V±30% Max. 6.8W	DC12V±30% Max. 7.5-W

Pro Series



4MP

Model	HAC-HFW2401R-Z-IRE6(-DP)	HAC-HDBW2401R-Z(-DP)	HAC-HDW2401R-Z(-DP)	HAC-HFW2401D	HAC-HFW2401E
Appearance					
Image Sensor	1/3" 4MP CMOS	1/3" 4MP CMOS	1/3" 4MP CMOS	1/3" 4MP CMOS	1/3" 4MP CMOS
Min. Illumination	0.01Lux/F1.3 (Color) 0Lux/F1.3 (IR On)	0.01Lux/F1.3 (Color) 0Lux/F1.3 (IR On)	0.01Lux/F1.3 (Color) 0Lux/F1.3 (IR On)	0.01Lux/F1.5 (Color) 0Lux/F1.5 (IR On)	0.01Lux/F1.5 (Color) 0Lux/F1.5 (IR On)
Lens	2.7~13.5mm, Motorized	2.7~13.5mm, Motorized	2.7~13.5mm, Motorized	3.6mm (6mm, 8mm Optional)	3.6mm (2.8mm, 6mm Optional)
FOV-H	98°~26°	98°~26°	98°~26°	79°(48.6°/32.9°)	79°(99.7°/48.6°)
Day/Night	ICR	ICR	ICR	ICR	ICR
Max. IR Distance	60m (197ft), Smart IR	30m (98ft), Smart IR	60m (197ft), Smart IR	80m (262ft), Smart IR	40m (131ft), Smart IR
OSD Menu	Multi-language	Multi-language	Multi-language	Multi-language	Multi-language
WDR	120dB	120dB	120dB	120dB	120dB
Noise Reduction	2D/3D	2D/3D	2D/3D	2D/3D	2D/3D
Frame Rate	25fps@4MP, 30fps@1080P 30fps@720P	25fps@4MP, 30fps@1080P 30fps@720P	25fps@4MP, 30fps@1080P 30fps@720P	25fps@4MP, 30fps@1080P 30fps@720P	25fps@4MP, 30fps@1080P 30fps@720P
Video Output	HD/SD Dual-output	HD/SD Dual-output	HD/SD Dual-output	HD/SD Dual-output	HD/SD Dual-output
Audio In	-	-	-	-	-
Alarm In/Out	-	-	-	-	-
Pan/Tilt/Rotation	Pan: 0°~360°; Tilt: 0°~87° Rotation: 0°~360°	Pan: 0°~355°; Tilt: 0°~75° Rotation: 0°~355°	Pan: 0°~360°; Tilt: 0°~78° Rotation: 0°~360°	Pan: 0°~360°; Tilt: 0°~87° Rotation: 0°~360°	Pan: 0°~360°; Tilt: 0°~90° Rotation: 0°~360°
Ingress Protection	IP67	IP67, IK10	IP67	IP67	IP67
Working Temperature	-30°C~+60°C (-22°F ~ +140°F)	-30°C~+60°C (-22°F ~ +140°F)	-30°C~+60°C (-22°F ~ +140°F)	-30°C~+60°C (-22°F ~ +140°F)	-30°C~+60°C (-22°F ~ +140°F)
Power	DC12V±25%, Max. 11.1W AC24V±25%/DC12V±25%, Max. 15.4W(-DP)	DC12V±25%, Max. 7.5W AC24V±25%/DC12V±25% Max. 10.1W(-DP)	DC12V±25%, Max. 8.4W AC24V±25%/DC12V±25% Max. 11.6W(-DP)	DC12V±25% Max. 6W	DC12V±25% Max. 5.9W

HDCVI CAMERAS

Pro Series

4MP

Model	HAC-HFW2401S	HAC-HDBW2401E	HAC-HDW2401EM(-A)	HAC-HDW2401M	HAC-EB2401
Appearance					
Image Sensor	1/3" 4MP CMOS	1/3" 4MP CMOS	1/3" 4MP CMOS	1/3" 4MP CMOS	1/3" 4MP CMOS
Min. Illumination	0.01Lux/F1.5 (Color) 0Lux/F1.5 (IR On)	0.01Lux/F1.5 (Color) 0Lux/F1.5 (IR On)	0.01Lux/F1.5 (Color) 0Lux/F1.5 (IR On)	0.01Lux/F1.5 (Color) 0Lux/F1.5 (IR On)	0.01Lux/F2.0 (Color) 0.001Lux/F2.0 (B/W)
Lens	3.6mm (2.8mm, 6mm Optional)	3.6mm (2.8mm, 6mm Optional)	3.6mm (2.8mm, 6mm Optional)	3.6mm (2.8mm, 6mm Optional)	1.18mm
FOV-H	79°(99.7°/48.6°)	79°(99.7°/48.6°)	79°(99.7°/48.6°)	79°(99.7°/48.6°)	180°
Day/Night	ICR	ICR	ICR	ICR	Electronic
Max. IR Distance	30m (98ft), Smart IR	30m (98ft), Smart IR	50m (164ft), Smart IR	30m (98ft), Smart IR	-
OSD Menu	Multi-language	Multi-language	Multi-language	Multi-language	Multi-language
WDR	120dB	120dB	120dB	120dB	120dB
Noise Reduction	2D/3D	2D/3D	2D/3D	2D/3D	2D/3D
Frame Rate	25fps@4MP, 30fps@1080P 30fps@720P	25fps@4MP, 30fps@1080P 30fps@720P	25fps@4MP, 30fps@1080P 30fps@720P	25fps@4MP, 30fps@1080P 30fps@720P	25fps@4MP, 30fps@1080P 30fps@720P
Video Output	HD/SD Dual-output	HD/SD Dual-output	HD/SD Dual-output	HD/SD Dual-output	HD/SD Dual-output
Audio In	-	-	Built-in Mic(-A)	-	-
Alarm In/Out	-	-	-	-	-
Pan/Tilt/Rotation	Pan: 0°~360°; Tilt: 0°~90° Rotation: 0°~360°	Pan: 0°~355°; Tilt: 0°~65° Rotation: 0°~355°	Pan: 0°~360°; Tilt: 0°~78° Rotation: 0°~360°	Pan: 0°~360°; Tilt: 0°~90° Rotation: 0°~360°	-
Ingress Protection	IP67	IP67, IK10	IP67	IP67	IK10
Working Temperature	-30°C~+60°C (-22°F ~ +140°F)	-30°C~+60°C (-22°F ~ +140°F)	-30°C~+60°C (-22°F ~ +140°F)	-30°C~+60°C (-22°F ~ +140°F)	-30°C~+60°C (-22°F ~ +140°F)
Power	DC12V±25% Max. 4.9W	DC12V±25% Max. 4.4W	DC12V±25% Max. 5.5W	DC12V±25% Max. 4.1W	DC12V±25% Max. 2.4W









Pro Series

1080P Starlight

Model	HAC-HFW2241T-Z-A(-DP)	HAC-HDBW2241R-Z(-DP)	HAC-HDW2241T-Z-A(-DP)	HAC-HFW2241T-I8-A	HAC-HFW2241E-A	HAC-HFW2241S	HAC-HDBW2241E
Appearance	 Starlight Fighter	 Starlight Fighter	 Starlight Fighter	 Starlight Fighter	 Starlight Fighter	 Starlight Fighter	 Starlight Fighter
Image Sensor	1/2.8" 2MP CMOS	1/2.8" 2MP CMOS	1/2.8" 2MP CMOS	1/2.8" 2MP CMOS	1/2.8" 2MP CMOS	1/2.8" 2MP CMOS	1/2.8" 2MP CMOS
Min. Illumination	0.004Lux/F1.6 (Color) 0Lux/F1.6 (IR On)	0.004Lux/F1.6 (Color) 0Lux/F1.6 (IR On)	0.004Lux/F1.6 (Color) 0Lux/F1.6 (IR On)	0.004Lux/F1.6 (Color) 0Lux/F1.6 (IR On)	0.004Lux/F1.6 (Color) 0Lux/F1.6 (IR On)	0.004Lux/F1.6 (Color) 0Lux/F1.6 (IR On)	0.004Lux/F1.6 (Color) 0Lux/F1.6 (IR On)
Lens	2.7~13.5mm, Motorized	2.7~13.5mm, Motorized	2.7~13.5mm, Motorized	3.6mm (6mm Optional)	3.6mm (2.8mm, 6mm Optional)	3.6mm (2.8mm, 6mm Optional)	3.6mm (2.8mm Optional)
FOV-H	108.7°~28.7°	108.7°~28.7°	108.7°~28.7°	86.9°(52.8°)	86.9°(110°/52.8°)	86.9°(110°/52.8°)	86.9°(110°)
Day/Night	ICR	ICR	ICR	ICR	ICR	ICR	ICR
Max. IR Distance	80m (262ft), Smart IR	30m (98ft), Smart IR	60m (197ft), Smart IR	80m (262ft), Smart IR	40m (131ft), Smart IR	30m (98ft), Smart IR	30m (98ft), Smart IR
OSD Menu	Multi-language	Multi-language	Multi-language	Multi-language	Multi-language	Multi-language	Multi-language
WDR	120dB	120dB	120dB	120dB	120dB	120dB	120dB
Noise Reduction	2D/3D	2D/3D	2D/3D	2D/3D	2D/3D	2D/3D	2D/3D
Frame Rate	30fps@1080P 30/60fps@720P	30fps@1080P 30/60fps@720P	30fps@1080P 30/60fps@720P	30fps@1080P 30/60fps@720P	30fps@1080P 30/60fps@720P	30fps@1080P 30/60fps@720P	30fps@1080P 30/60fps@720P
Video Output	HD/SD Switchable	HD/SD Switchable	HD/SD Switchable	HD/SD Switchable	HD/SD Switchable	HD/SD Switchable	HD/SD Switchable
Audio In	1ch in & Built-in Mic	1	1ch in & Built-in Mic	1ch in & Built-in Mic	1ch in & Built-in Mic	1	1
Alarm In/Out	-	-	-	-	-	-	-
Pan/Tilt/Rotation	Pan: 0°~360°; Tilt: 0°~90° Rotation: 0°~360°	Pan: 0°~355°; Tilt: 0°~75° Rotation: 0°~355°	Pan: 0°~360°; Tilt: 0°~78° Rotation: 0°~360°	Pan: 0°~360°; Tilt: 0°~90° Rotation: 0°~360°	Pan: 0°~360°; Tilt: 0°~90° Rotation: 0°~360°	Pan: 0°~360°; Tilt: 0°~90° Rotation: 0°~360°	Pan: 0°~355°; Tilt: 0°~65° Rotation: 0°~355°
Ingress Protection	IP67	IP67, IK10	IP67	IP67	IP67	IP67	IP67, IK10
Working Temperature	-40°C~+60°C (-40°F ~ +140°F)	-40°C~+60°C (-40°F ~ +140°F)	-40°C~+60°C (-40°F ~ +140°F)	-40°C~+60°C (-40°F ~ +140°F)	-40°C~+60°C (-40°F ~ +140°F)	-40°C~+60°C (-40°F ~ +140°F)	-40°C~+60°C (-40°F ~ +140°F)
Power	DC12V±30%, Max. 8.2W AC24V±30%/DC12V±30% Max. 11.1W(-DP) Output: DC12V, Max. 2W(-DP)	DC12V±30%, Max. 4.7W AC24V±30%/DC12V±30% Max. 5.9W(-DP) Output: DC12V, Max. 2W(-DP)	DC12V±30%, Max. 5.4W AC24V±30%/DC12V±30% Max. 6.9W(-DP) Output: DC12V, Max. 2W(-DP)	DC12V±30% Max. 10.1W	DC12V±30% Max. 6.7W	DC12V±30% Max. 5.86W	DC12V±30% Max. 4.4W

HDCVI CAMERAS

Pro Series

	1080P Starlight			1080P Full Color			1080P PoC	
Model	HAC-HDBW2241F-A	HAC-HDW2241T-A	HAC-HDW2241M	HAC-HFW2249T-I8-A	HAC-HFW2249E-A	HAC-HDW2249T-A	HAC-HFW2231R-Z-IRE6-POC	HAC-HDBW2231R-Z-POC
Appearance	 Starlight Fighter	 Starlight Fighter	 Starlight Fighter	 Starlight Fighter	 Starlight Fighter	 Starlight Fighter	 PoC Starlight	 PoC Starlight
Image Sensor	1/2.8" 2MP CMOS	1/2.8" 2MP CMOS	1/2.8" 2MP CMOS	1/2.8" 2MP CMOS	1/2.8" 2MP CMOS	1/2.8" 2MP CMOS	1/2.8" 2MP STARVIS™ CMOS	1/2.8" 2MP STARVIS™ CMOS
Min. Illumination	0.004Lux/F1.6 (Color) 0Lux/F1.6 (IR On)	0.004Lux/F1.6 (Color) 0Lux/F1.6 (IR On)	0.004Lux/F1.6 (Color) 0Lux/F1.6 (IR On)	0.001Lux/F1.0 (Color)	0.001Lux/F1.0 (Color)	0.001Lux/F1.0 (Color)	0.005Lux/F1.6 (Color) 0Lux/F1.6 (IR On)	0.005Lux/F1.6 (Color) 0Lux/F1.6 (IR On)
Lens	3.6mm (2.8mm Optional)	3.6mm (2.8mm, 6mm Optional)	3.6mm (2.8mm, 6mm Optional)	3.6mm (6mm Optional)	3.6mm (6mm Optional)	3.6mm (6mm Optional)	2.7~13.5mm, Motorized	2.7~13.5mm, Motorized
FOV-H	86.9°(110°)	86.9°(110°/52.8°)	86.9°(110°/52.8°)	89.5°(53.8°)	89.5°(53.8°)	89.5°(53.8°)	99°~29°	99°~29°
Day/Night	ICR	ICR	ICR	Color	Color	Color	ICR	ICR
Max. IR Distance	20m (66ft), Smart IR	50m (164ft), Smart IR	30m (98ft), Smart IR	-	-	-	60m (197ft), Smart IR	30m (98ft), Smart IR
OSD Menu	Multi-language	Multi-language	Multi-language	Multi-language	Multi-language	Multi-language	Multi-language	Multi-language
WDR	120dB	120dB	120dB	120dB	120dB	120dB	120dB	120dB
Noise Reduction	2D/3D	2D/3D	2D/3D	2D/3D	2D/3D	2D/3D	2D/3D	2D/3D
Frame Rate	30fps@1080P 30/60fps@720P	30fps@1080P 30/60fps@720P	30fps@1080P 30/60fps@720P	30fps@1080P 30/60fps@720P	30fps@1080P 30/60fps@720P	30fps@1080P 30/60fps@720P	30fps@1080P, 30fps@720P	30fps@1080P, 30fps@720P
Video Output	HD/SD Switchable	HD/SD Switchable	HD/SD Switchable	HD/SD Switchable	HD/SD Switchable	HD/SD Switchable	HD/SD Switchable	HD/SD Switchable
Audio In	1ch in & Built-in Mic	1ch in & Built-in Mic	1	1ch in & Built-in Mic	1ch in & Built-in Mic	1ch in & Built-in Mic	-	-
Alarm In/Out	-	-	-	-	-	-	-	-
Pan/Tilt/Rotation	Pan: 0°~60°; Tilt: 0°~80° Rotation: 0°~360°	Pan: 0°~360°; Tilt: 0°~78° Rotation: 0°~360°	Pan: 0°~360°; Tilt: 0°~90° Rotation: 0°~360°	Pan: 0°~360°; Tilt: 0°~90° Rotation: 0°~360°	Pan: 0°~360°; Tilt: 0°~90° Rotation: 0°~360°	Pan: 0°~360°; Tilt: 0°~78° Rotation: 0°~360°	Pan: 0°~360°; Tilt: 0°~87° Rotation: 0°~360°	Pan: 0°~355°; Tilt: 0°~75° Rotation: 0°~355°
Ingress Protection	IP67, IK10	IP67	IP67	IP67	IP67	IP67	IP67	IP67, IK10
Working Temperature	-40°C~+60°C (-40°F ~ +140°F)	-40°C~+60°C (-40°F ~ +140°F)	-40°C~+60°C (-40°F ~ +140°F)	-40°C~+60°C (-40°F ~ +140°F)	-40°C~+60°C (-40°F ~ +140°F)	-40°C~+60°C (-40°F ~ +140°F)	-40°C~+60°C (-40°F ~ +140°F)	-40°C~+60°C (-40°F ~ +140°F)
Power	DC12V±30% Max. 3.4W	DC12V±30% Max. 5.3W	DC12V±30% Max. 4.7W	DC12V±30% Max. 2.4W	DC12V±30% Max. 2.4W	DC12V±30% Max. 2.4W	PoC/DC12V±25% Max. 6.3W	POC/DC12V±25% Max. 8.8W Output: DC12V, Max. 2W

Lite Series

The Lite Series is suitable for users who want high quality at an affordable price. It features a superior cost/performance suitable for residential and small-medium business applications. The series offers a wide range of resolutions with vari-focal/fix lens options to fit every scenario.

⊕ KEY FEATURES

High Performance

Missile/Cannon ISP delivers high quality, HD/SD output

Compact Design



Flexible and can fit in a number of places

Cost-Effective

Performance and quality are combined at an affordable price

Lite Series









4MP

Model	HAC-HFW1400R-VF-IRE6	HAC-HFW1400R-VF	HAC-HDBW1400R-VF	HAC-HDW1400R-VF
Appearance	 Missile	 Missile	 Missile	 Missile
Image Sensor	1/3" 4MP CMOS	1/3" 4MP CMOS	1/3" 4MP CMOS	1/3" 4MP CMOS
Min. Illumination	0.03Lux/F1.3 (Color) 0Lux/F1.3 (IR On)	0.03Lux/F1.3 (Color) 0Lux/F1.3 (IR On)	0.03Lux/F1.3 (Color) 0Lux/F1.3 (IR On)	0.03Lux/F1.3 (Color) 0Lux/F1.3 (IR On)
Lens	2.7~13.5mm, Manual	2.7~13.5mm, Manual	2.7~13.5mm, Manual	2.7~13.5mm, Manual
FOV-H	98°~26°	98°~26°	98°~26°	98°~26°
Day/Night	ICR	ICR	ICR	ICR
Max. IR Distance	60m (197ft), Smart IR	30m (98ft), Smart IR	30m (98ft), Smart IR	30m (98ft), Smart IR
OSD Menu	Multi-language	Multi-language	Multi-language	Multi-language
WDR	DWDR	DWDR	DWDR	DWDR
Noise Reduction	2D	2D	2D	2D
Frame Rate	30fps@4MP 30fps@1080P, 30fps@720P	30fps@4MP 30fps@1080P, 30fps@720P	30fps@4MP 30fps@1080P, 30fps@720P	30fps@4MP 30fps@1080P, 30fps@720P
Video Output	HD/SD Switchable	HD/SD Switchable	HD/SD Switchable	HD/SD Switchable
Audio In	-	-	-	-
Alarm In/Out	-	-	-	-
Pan/Tilt/Rotation	Pan: 0°~360°; Tilt: 0°~87° Rotation: 0°~360°	Pan: 0°~360°; Tilt: 0°~87° Rotation: 0°~360°	Pan: 0°~355°; Tilt: 0°~75° Rotation: 0°~355°	Pan: 0°~360°; Tilt: 0°~90° Rotation: 0°~360°
Ingress Protection	IP67	IP67	IP67, IK10	IP67
Working Temperature	-40°C~+60°C (-40°F ~ +140°F)	-40°C~+60°C (-40°F ~ +140°F)	-40°C~+60°C (-40°F ~ +140°F)	-40°C~+60°C (-40°F ~ +140°F)
Power	DC12V±25% Max. 7.6W	DC12V±25% Max. 4.6W	DC12V±25% Max. 4.1W	DC12V±25% Max. 4.6W

HDCVI CAMERAS









Lite Series

4MP

Model	HAC-HFW1400D	HAC-HFW1400B	HAC-HFW1400S	HAC-HFW1400S-POC	HAC-HFW1400SL	HAC-HFW1400T	HAC-HFW1400R	HAC-HDBW1400E
Appearance	 Missile	 Missile	 Missile	 PoC Missile	 Missile	 Missile	 Missile	 Missile
Image Sensor	1/3" 4MP CMOS	1/3" 4MP CMOS	1/3" 4MP CMOS	1/3" 4MP CMOS	1/3" 4MP CMOS	1/3" 4MP CMOS	1/3" 4MP CMOS	1/3" 4MP CMOS
Min. Illumination	0.03Lux/F1.9 (Color) 0Lux/F1.9 (IR On)	0.03Lux/F1.9 (Color) 0Lux/F1.9 (IR On)	0.03Lux/F1.9 (Color) 0Lux/F1.9 (IR On)	0.03Lux/F1.9 (Color) 0Lux/F1.9 (IR On)	0.03Lux/F1.9 (Color) 0Lux/F1.9 (IR On)	0.03Lux/F1.9 (Color) 0Lux/F1.9 (IR On)	0.03Lux/F1.9 (Color) 0Lux/F1.9 (IR On)	0.03Lux/F1.9 (Color) 0Lux/F1.9 (IR On)
Lens	3.6mm (6mm, 8mm, 12mm Optional)	3.6mm (6mm, 8mm Optional)	3.6mm (2.8mm, 6mm, 8mm Optional)	3.6mm (2.8mm, 6mm)	3.6mm (2.8mm, 6mm, 8mm Optional)	3.6mm (2.8mm, 6mm Optional)	3.6mm (2.8mm, 6mm Optional)	3.6mm (2.8mm, 6mm Optional)
FOV-H	78°(48.6°/32.9°/23.6°)	78°(48.6°/32.9°)	78°(99.7°/48.6°/32.9°)	78°(99.7°/48.6°)	78°(99.7°/48.6°/32.9°)	78°(99.7°/48.6°)	78°(99.7°/48.6°)	78°(99.7°/48.6°)
Day/Night	ICR	ICR	ICR	ICR	ICR	ICR	ICR	ICR
Max. IR Distance	80m (262ft), Smart IR	50m (164ft), Smart IR	30m (98ft), Smart IR	30m (98ft), Smart IR	30m (98ft), Smart IR	20m (66ft), Smart IR	20m (66ft), Smart IR	30m (98ft), Smart IR
OSD Menu	Multi-language	Multi-language	Multi-language	Multi-language	Multi-language	Multi-language	Multi-language	Multi-language
WDR	DWDR	DWDR	DWDR	DWDR	DWDR	DWDR	DWDR	DWDR
Noise Reduction	2D	2D	2D	2D	2D	2D	2D	2D
Frame Rate	30fps@4MP 30fps@1080P, 30fps@720P	30fps@4MP 30fps@1080P, 30fps@720P	30fps@4MP 30fps@1080P, 30fps@720P	30fps@4MP 30fps@1080P, 30fps@720P	30fps@4MP 30fps@1080P, 30fps@720P	30fps@4MP 30fps@1080P, 30fps@720P	30fps@4MP 30fps@1080P, 30fps@720P	30fps@4MP 30fps@1080P, 30fps@720P
Video Output	HD/SD Switchable	HD/SD Switchable	HD/SD Switchable	HD/SD Switchable	HD/SD Switchable	HD/SD Switchable	HD/SD Switchable	HD/SD Switchable
Audio In	-	-	-	-	-	-	-	-
Alarm In/Out	-	-	-	-	-	-	-	-
Pan/Tilt/Rotation	Pan: 0°~360°; Tilt: 0°~87° Rotation: 0°~360°	Pan: 0°~360°; Tilt: 0°~87° Rotation: 0°~360°	Pan: 0°~360°; Tilt: 0°~90° Rotation: 0°~360°	Pan: 0°~360°; Tilt: 0°~90° Rotation: 0°~360°	Pan: 0°~360°; Tilt: 0°~90° Rotation: 0°~360°	Pan: 0°~360°; Tilt: 0°~90° Rotation: 0°~360°	Pan: 0°~360°; Tilt: 0°~90° Rotation: 0°~360°	Pan: 0°~355°; Tilt: 0°~65° Rotation: 0°~355°
Ingress Protection	IP67	IP67	IP67	IP67	IP67	IP67	IP67	IP67, IK10
Working Temperature	-40°C~+60°C (-40°F ~ +140°F)	-40°C~+60°C (-40°F ~ +140°F)	-40°C~+60°C (-40°F ~ +140°F)	-40°C~+60°C (-40°F ~ +140°F)	-40°C~+60°C (-40°F ~ +140°F)	-40°C~+60°C (-40°F ~ +140°F)	-40°C~+60°C (-40°F ~ +140°F)	-40°C~+60°C (-40°F ~ +140°F)
Power	DC12V±25% Max. 5.2W	DC12V±25% Max. 4.1W	DC12V±25% Max. 4.6W	POC/DC12V±25% Max. 4.4W	DC12V±25% Max. 4.6W	DC12V±25% Max. 3.2W	DC12V±25% Max. 3.2W	DC12V±25% Max. 3.6W

HDCVI CAMERAS









Lite Series

	4MP				1080P			
Model	HAC-HDW1400EM(-A)	HAC-HDW1400EM-POC	HAC-HDW1400M	HAC-HDW1400R	HAC-HFW1220R-VF-IRE6	HAC-HFW1200R-VF-IRE6	HAC-HFW1220R-VF	HAC-HFW1200R-VF
Appearance	 Missile	 PoC Missile	 Missile	 Missile	 Cannon	 Cannon	 Cannon	 Cannon
Image Sensor	1/3" 4MP CMOS	1/3" 4MP CMOS	1/3" 4MP CMOS	1/3" 4MP CMOS	1/2.9" 2MP CMOS	1/2.7" 2MP CMOS	1/2.9" 2MP CMOS	1/2.7" 2MP CMOS
Min. Illumination	0.03Lux/F1.9 (Color) 0Lux/F1.9 (IR On)	0.03Lux/F1.9 (Color) 0Lux/F1.9 (IR On)	0.03Lux/F1.9 (Color) 0Lux/F1.9 (IR On)	0.03Lux/F1.9 (Color) 0Lux/F1.9 (IR On)	0.02Lux/F1.3 (Color) 0Lux/F1.3 (IR On)	0.02Lux/F1.3 (Color) 0Lux/F1.3 (IR On)	0.02Lux/F1.3 (Color) 0Lux/F1.3 (IR On)	0.02Lux/F1.3 (Color) 0Lux/F1.3 (IR On)
Lens	3.6mm (2.8mm, 6mm, 8mm Optional)	3.6mm (2.8mm, 6mm)	3.6mm (2.8mm, 6mm Optional)	3.6mm (2.8mm, 6mm Optional)	2.7~13.5mm, Manual	2.7~13.5mm, Manual	2.7~13.5mm, Manual	2.7~13.5mm, Manual
FOV-H	78°(99.7°/48.6°/32.9°)	78°(99.7°/48.6°)	78°(99.7°/48.6°)	78°(99.7°/48.6°)	104°~28°	106°~30°	104°~28°	106°~30°
Day/Night	ICR	ICR	ICR	ICR	ICR	ICR	ICR	ICR
Max. IR Distance	50m (164ft), Smart IR	50m (164ft), Smart IR	30m (98ft), Smart IR	20m (66ft), Smart IR	60m (197ft), Smart IR	60m (197ft), Smart IR	30m (98ft), Smart IR	30m (98ft), Smart IR
OSD Menu	Multi-language	Multi-language	Multi-language	Multi-language	Multi-language	Multi-language	Multi-language	Multi-language
WDR	DWDR	DWDR	DWDR	DWDR	DWDR	DWDR	DWDR	DWDR
Noise Reduction	2D	2D	2D	2D	2D	2D	2D	2D
Frame Rate	30fps@4MP 30fps@1080P, 30fps@720P	30fps@4MP 30fps@1080P, 30fps@720P	30fps@4MP 30fps@1080P, 30fps@720P	30fps@4MP 30fps@1080P, 30fps@720P	30fps@1080P 30/60fps@720P	30fps@1080P 30/60fps@720P	30fps@1080P 30/60fps@720P	30fps@1080P 30/60fps@720P
Video Output	HD/SD Switchable	HD/SD Switchable	HD/SD Switchable	HD/SD Switchable	HD/SD Switchable	HD/SD Switchable	HD/SD Switchable	HD/SD Switchable
Audio In	Built-in Mic(-A)	-	-	-	-	-	-	-
Alarm In/Out	-	-	-	-	-	-	-	-
Pan/Tilt/Rotation	Pan: 0°~360°; Tilt: 0°~78° Rotation: 0°~360°	Pan: 0°~360°; Tilt: 0°~78° Rotation: 0°~360°	Pan: 0°~360°; Tilt: 0°~90° Rotation: 0°~360°	Pan: 0°~360°; Tilt: 0°~90° Rotation: 0°~360°	Pan: 0°~360°; Tilt: 0°~87° Rotation: 0°~360°	Pan: 0°~360°; Tilt: 0°~87° Rotation: 0°~360°	Pan: 0°~360°; Tilt: 0°~87° Rotation: 0°~360°	Pan: 0°~360°; Tilt: 0°~87° Rotation: 0°~360°
Ingress Protection	IP67	IP67	IP67	-	IP67	IP67	IP67	IP67
Working Temperature	-40°C~+60°C (-40°F ~ +140°F)	-40°C~+60°C (-40°F ~ +140°F)	-40°C~+60°C (-40°F ~ +140°F)	-40°C~+60°C (-40°F ~ +140°F)	-40°C~+60°C (-40°F ~ +140°F)	-40°C~+60°C (-40°F ~ +140°F)	-40°C~+60°C (-40°F ~ +140°F)	-40°C~+60°C (-40°F ~ +140°F)
Power	DC12V±25% Max. 4.1W	POC/DC12V±25% Max. 4.6W	DC12V±25% Max. 3.2W	DC12V±25% Max. 3.2W	DC12V±25% Max. 7.7W	DC12V±25% Max. 7.9W	DC12V±25% Max. 4.2W	DC12V±25% Max. 4.4W

HDCVI CAMERAS









Lite Series

1080P

Model	HAC-HDBW1220R-VF	HAC-HDBW1200R-VF	HAC-HDW1220R-VF	HAC-HDW1200R-VF	HAC-HFW1220D	HAC-HFW1200D	HAC-HFW1220B	HAC-HFW1200B
Appearance	 Cannon	 Cannon	 Cannon	 Cannon	 Cannon	 Cannon	 Cannon	 Cannon
Image Sensor	1/2.9" 2MP CMOS	1/2.7" 2MP CMOS	1/2.9" 2MP CMOS	1/2.7" 2MP CMOS	1/2.9" 2MP CMOS	1/2.7" 2MP CMOS	1/2.9" 2MP CMOS	1/2.7" 2MP CMOS
Min. Illumination	0.02Lux/F1.3 (Color) 0Lux/F1.3 (IR On)	0.02Lux/F1.3 (Color) 0Lux/F1.3 (IR On)	0.02Lux/F1.3 (Color) 0Lux/F1.3 (IR On)	0.02Lux/F1.3 (Color) 0Lux/F1.3 (IR On)	0.02Lux/F2.0 (Color) 0Lux/F2.0 (IR On)	0.02Lux/F1.85 (Color) 0Lux/F1.85 (IR On)	0.02Lux/F2.0 (Color) 0Lux/F2.0 (IR On)	0.02Lux/F1.85 (Color) 0Lux/F1.85 (IR On)
Lens	2.7~13.5mm, Manual	2.7~13.5mm, Manual	2.7~13.5mm, Manual	2.7~13.5mm, Manual	3.6mm (6mm, 8mm Optional)	3.6mm (6mm, 8mm Optional)	3.6mm (2.8mm, 6mm, 8mm Optional)	3.6mm (6mm, 8mm Optional)
FOV-H	104°~28°	106°~30°	104°~28°	106°~30°	82.8°(51°/35.1°)	89.9°(54.7°/41.6°)	82.8°(106°/51°/35.1°)	89.9°(54.7°/41.6°)
Day/Night	ICR	ICR	ICR	ICR	ICR	ICR	ICR	ICR
Max. IR Distance	30m (98ft), Smart IR	30m (98ft), Smart IR	30m (98ft), Smart IR	30m (98ft), Smart IR	80m (262ft), Smart IR	80m (262ft), Smart IR	50m (164ft), Smart IR	50m (164ft), Smart IR
OSD Menu	Multi-language	Multi-language	Multi-language	Multi-language	Multi-language	Multi-language	Multi-language	Multi-language
WDR	DWDR	DWDR	DWDR	DWDR	DWDR	DWDR	DWDR	DWDR
Noise Reduction	2D	2D	2D	2D	2D	2D	2D	2D
Frame Rate	30fps@1080P 30/60fps@720P	30fps@1080P 30/60fps@720P	30fps@1080P 30/60fps@720P	30fps@1080P 30/60fps@720P	30fps@1080P 30/60fps@720P	30fps@1080P 30/60fps@720P	30fps@1080P 30/60fps@720P	30fps@1080P 30/60fps@720P
Video Output	HD/SD Switchable	HD/SD Switchable	HD/SD Switchable	HD/SD Switchable	HD/SD Switchable	HD/SD Switchable	HD/SD Switchable	HD/SD Switchable
Audio In	-	-	-	-	-	-	-	-
Alarm In/Out	-	-	-	-	-	-	-	-
Pan/Tilt/Rotation	Pan: 0°~355°; Tilt: 0°~75° Rotation: 0°~355°	Pan: 0°~355°; Tilt: 0°~75° Rotation: 0°~355°	Pan: 0°~360°; Tilt: 0°~90° Rotation: 0°~360°	Pan: 0°~360°; Tilt: 0°~90° Rotation: 0°~360°	Pan: 0°~360°; Tilt: 0°~87° Rotation: 0°~360°	Pan: 0°~360°; Tilt: 0°~87° Rotation: 0°~360°	Pan: 0°~360°; Tilt: 0°~87° Rotation: 0°~360°	Pan: 0°~360°; Tilt: 0°~87° Rotation: 0°~360°
Ingress Protection	IP67, IK10	IP67, IK10	IP67	IP67	IP67	IP67	IP67	IP67
Working Temperature	-40°C~+60°C (-40°F ~ +140°F)	-40°C~+60°C (-40°F ~ +140°F)	-40°C~+60°C (-40°F ~ +140°F)	-40°C~+60°C (-40°F ~ +140°F)	-40°C~+60°C (-40°F ~ +140°F)	-40°C~+60°C (-40°F ~ +140°F)	-40°C~+60°C (-40°F ~ +140°F)	-40°C~+60°C (-40°F ~ +140°F)
Power	DC12V±25% Max. 3.4W	DC12V±25% Max. 3.4W	DC12V±25% Max. 4.2W	DC12V±25% Max. 4.4W	DC12V±25% Max. 4.5W	DC12V±25% Max. 5W	DC12V±25% Max. 4W	DC12V±25% Max. 4W

Lite Series









1080P

Model	HAC-HFW1220S	HAC-HFW1200S	HAC-HFW1200S-POC	HAC-HFW1220SL	HAC-HFW1200SL	HAC-HFW1220RM	HAC-HFW1200RM	HAC-HFW1200T
Appearance	 Cannon	 Cannon	 PoC Cannon	 Cannon	 Cannon	 Cannon	 Cannon	 Cannon
Image Sensor	1/2.9" 2MP CMOS	1/2.7" 2MP CMOS	1/2.7" 2MP CMOS	1/2.9" 2MP CMOS	1/2.7" 2MP CMOS	1/2.9" 2MP CMOS	1/2.7" 2MP CMOS	1/2.7" 2MP CMOS
Min. Illumination	0.02Lux/F2.0 (Color) 0Lux/F2.0 (IR On)	0.02Lux/F1.85 (Color) 0Lux/F1.85 (IR On)	0.02Lux/F1.85 (Color) 0Lux/F1.85 (IR On)	0.02Lux/F2.0 (Color) 0Lux/F2.0 (IR On)	0.02Lux/F1.85 (Color) 0Lux/F1.85 (IR On)	0.02Lux/F2.0 (Color) 0Lux/F2.0 (IR On)	0.02Lux/F1.85 (Color) 0Lux/F1.85 (IR On)	0.02Lux/F1.85 (Color) 0Lux/F1.85 (IR On)
Lens	3.6mm (2.8mm, 6mm Optional)	3.6mm (2.8mm, 6mm Optional)	3.6mm (2.8mm, 6mm Optional)	3.6mm (2.8mm, 6mm Optional)	3.6mm (2.8mm, 6mm Optional)	3.6mm (2.8mm, 6mm Optional)	3.6mm (2.8mm, 6mm Optional)	3.6mm (2.8mm, 6mm Optional)
FOV-H	82.8°(106°/51°)	89.9°(103°/54.7°)	89.9°(103°/54.7°)	82.8°(106°/51°)	89.9°(103°/54.7°)	82.8°(106°/51°)	89.9°(103°/54.7°)	89.9°(103°/54.7°)
Day/Night	ICR	ICR	ICR	ICR	ICR	ICR	ICR	ICR
Max. IR Distance	30m (98ft), Smart IR	30m (98ft), Smart IR	30m (98ft), Smart IR	30m (98ft), Smart IR	30m (98ft), Smart IR	20m (66ft), Smart IR	20m (66ft), Smart IR	20m (66ft), Smart IR
OSD Menu	Multi-language	Multi-language	Multi-language	Multi-language	Multi-language	Multi-language	Multi-language	Multi-language
WDR	DWDR	DWDR	DWDR	DWDR	DWDR	DWDR	DWDR	DWDR
Noise Reduction	2D	2D	2D	2D	2D	2D	2D	2D
Frame Rate	30fps@1080P 30/60fps@720P	30fps@1080P 30/60fps@720P	30fps@1080P, 30/60fps@720P	30fps@1080P 30/60fps@720P	30fps@1080P 30/60fps@720P	30fps@1080P 30/60fps@720P	30fps@1080P 30/60fps@720P	30fps@1080P 30/60fps@720P
Video Output	HD/SD Switchable	HD/SD Switchable	HD/SD Switchable	HD/SD Switchable	HD/SD Switchable	HD/SD Switchable	HD/SD Switchable	HD/SD Switchable
Audio In	-	-	-	-	-	-	-	-
Alarm In/Out	-	-	-	-	-	-	-	-
Pan/Tilt/Rotation	Pan: 0°~360°; Tilt: 0°~90° Rotation: 0°~360°	Pan: 0°~360°; Tilt: 0°~90° Rotation: 0°~360°	Pan: 0°~360°; Tilt: 0°~90° Rotation: 0°~360°	Pan: 0°~360°; Tilt: 0°~90° Rotation: 0°~360°	Pan: 0°~360°; Tilt: 0°~90° Rotation: 0°~360°	Pan: 0°~360°; Tilt: 0°~90° Rotation: 0°~360°	Pan: 0°~360°; Tilt: 0°~90° Rotation: 0°~360°	Pan: 0°~360°; Tilt: 0°~90° Rotation: 0°~360°
Ingress Protection	IP67	IP67	IP67	IP67	IP67	IP67	IP67	IP67
Working Temperature	-40°C~+60°C (-40°F ~ +140°F)	-40°C~+60°C (-40°F ~ +140°F)	-40°C~+60°C (-40°F ~ +140°F)	-40°C~+60°C (-40°F ~ +140°F)	-40°C~+60°C (-40°F ~ +140°F)	-40°C~+60°C (-40°F ~ +140°F)	-40°C~+60°C (-40°F ~ +140°F)	-40°C~+60°C (-40°F ~ +140°F)
Power	DC12V±25% Max. 3.9W	DC12V±25% Max. 4.2W	POC/DC12V±25% Max. 4.2W	DC12V±25% Max. 3.9W	DC12V±25% Max. 4.2W	DC12V±25% Max. 2.8W	DC12V±25% Max. 3.2W	DC12V±25% Max. 3.2W

HDCVI CAMERAS









Lite Series

1080P

Model	HAC-HFW1220R	HAC-HFW1200R	HAC-HDBW1220E	HAC-HDBW1200E	HAC-HDPW1200R	HAC-HDW1220EM(-A)	HAC-HDW1200EM(-A)	HAC-HDW1200EM-POC
Appearance	 Cannon	 Cannon	 Cannon	 Cannon	 Cannon	 Cannon	 Cannon	 PoC Cannon
Image Sensor	1/2.9" 2MP CMOS	1/2.7" 2MP CMOS	1/2.9" 2MP CMOS	1/2.7" 2MP CMOS	1/2.7" 2MP CMOS	1/2.9" 2MP CMOS	1/2.7" 2MP CMOS	1/2.7" 2MP CMOS
Min. Illumination	0.02Lux/F2.0 (Color) 0Lux/F2.0 (IR On)	0.02Lux/F1.85 (Color) 0Lux/F1.85 (IR On)	0.02Lux/F2.0 (Color) 0Lux/F2.0 (IR On)	0.02Lux/F1.85 (Color) 0Lux/F1.85 (IR On)	0.02Lux/F1.85 (Color) 0Lux/F1.85 (IR On)	0.02Lux/F2.0 (Color) 0Lux/F2.0 (IR On)	0.02Lux/F1.85 (Color) 0Lux/F1.85 (IR On)	0.02Lux/F1.85 (Color) 0Lux/F1.85 (IR On)
Lens	3.6mm (2.8mm, 6mm Optional)	3.6mm (2.8mm, 6mm Optional)	3.6mm (2.8mm, 6mm Optional)	3.6mm (2.8mm, 6mm Optional)	3.6mm (2.8mm Optional)	3.6mm (2.8mm, 6mm Optional)	3.6mm (2.8mm, 6mm Optional)	3.6mm (2.8mm, 6mm Optional)
FOV-H	82.8°(106°/51°)	89.9°(103°/54.7°)	82.8°(106°/51°)	89.9°(115.6°/54.7°)	89.9°(103°)	82.8°(106°/51°)	89.9°(103°/54.7°)	89.9°(103°/54.7°)
Day/Night	ICR	ICR	ICR	ICR	ICR	ICR	ICR	ICR
Max. IR Distance	20m (66ft), Smart IR	20m (66ft), Smart IR	30m (98ft), Smart IR	30m (98ft), Smart IR	20m (66ft), Smart IR	50m (164ft), Smart IR	50m (164ft), Smart IR	50m (164ft), Smart IR
OSD Menu	Multi-language	Multi-language	Multi-language	Multi-language	Multi-language	Multi-language	Multi-language	Multi-language
WDR	DWDR	DWDR	DWDR	DWDR	DWDR	DWDR	DWDR	DWDR
Noise Reduction	2D	2D	2D	2D	2D	2D	2D	2D
Frame Rate	30fps@1080P 30/60fps@720P	30fps@1080P 30/60fps@720P	30fps@1080P 30/60fps@720P	30fps@1080P 30/60fps@720P	30fps@1080P 30/60fps@720P	30fps@1080P 30/60fps@720P	30fps@1080P 30/60fps@720P	30fps@1080P 30/60fps@720P
Video Output	HD/SD Switchable	HD/SD Switchable	HD/SD Switchable	HD/SD Switchable	HD/SD Switchable	HD/SD Switchable	HD/SD Switchable	HD/SD Switchable
Audio In	-	-	-	-	-	Built-in Mic(-A)	Built-in Mic(-A)	-
Alarm In/Out	-	-	-	-	-	-	-	-
Pan/Tilt/Rotation	Pan: 0°~360°; Tilt: 0°~90° Rotation: 0°~360°	Pan: 0°~360°; Tilt: 0°~90° Rotation: 0°~360°	Pan: 0°~355°; Tilt: 0°~65° Rotation: 0°~355°	Pan: 0°~355°; Tilt: 0°~65° Rotation: 0°~355°	Pan: 0°~355°; Tilt: 0°~70° Rotation: 0°~355°	Pan: 0°~360°; Tilt: 0°~78° Rotation: 0°~360°	Pan: 0°~360°; Tilt: 0°~78° Rotation: 0°~360°	Pan: 0°~360°; Tilt: 0°~78° Rotation: 0°~360°
Ingress Protection	IP67	IP67	IP67, IK10	IP67, IK10	-	IP67	IP67	IP67
Working Temperature	-40°C~+60°C (-40°F ~ +140°F)	-40°C~+60°C (-40°F ~ +140°F)	-40°C~+60°C (-40°F ~ +140°F)	-40°C~+60°C (-40°F ~ +140°F)	-40°C~+45°C (-40°F ~ +104°F)	-40°C~+60°C (-40°F ~ +140°F)	-40°C~+60°C (-40°F ~ +140°F)	-40°C~+60°C (-40°F ~ +140°F)
Power	DC12V±25% Max. 2.8W	DC12V±25% Max. 3.2W	DC12V±25% Max. 2.6W	DC12V±25% Max. 3.2W	DC12V±25% Max. 2.9W	DC12V±25% Max. 2.9W	DC12V±25% Max. 3.2W	POC/DC12V±25% Max. 3.4W

Lite Series







1080P

Model	HAC-HDW1220M	HAC-HDW1200M	HAC-HDW1220G	HAC-HDW1200L	HAC-HDW1200SL	HAC-HDW1220R	HAC-HDW1200R	HAC-HUM1220G(-B)	HAC-HUM1220G-B-P
Appearance	 Cannon	 Cannon	 Cannon	 Cannon	 Cannon	 Cannon	 Cannon	 Cannon	 Cannon
Image Sensor	1/2.9" 2MP CMOS	1/2.7" 2MP CMOS	1/2.9" 2MP CMOS	1/2.7" 2MP CMOS	1/2.7" 2MP CMOS	1/2.9" 2MP CMOS	1/2.7" 2MP CMOS	1/2.9" 2MP CMOS	1/2.9" 2MP CMOS
Min. Illumination	0.02Lux/F2.0 (Color) 0Lux/F2.0 (IR On)	0.02Lux/F1.85 (Color) 0Lux/F1.85 (IR On)	0.02Lux/F2.0 (Color) 0Lux/F2.0 (IR On)	0.02Lux/F1.85 (Color) 0Lux/F1.85 (IR On)	0.02Lux/F1.85 (Color) 0Lux/F1.85 (IR On)	0.02Lux/F2.0 (Color) 0Lux/F2.0 (IR On)	0.02Lux/F1.85 (Color) 0Lux/F1.85 (IR On)	0.02Lux/F2.0 (Color) 0.002Lux/F2.0 (B/W)	0.02Lux/F2.0 (Color) 0.002Lux/F2.0 (B/W)
Lens	3.6mm (2.8mm, 6mm Optional)	3.6mm (2.8mm, 6mm Optional)	3.6mm (6mm Optional)	2.1mm	3.6mm (2.8mm Optional)	3.6mm (2.8mm, 6mm Optional)	3.6mm (2.8mm, 6mm Optional)	3.6mm (2.1mm, 2.8mm Optional)	2.8mm
FOV-H	82.8°(106°/51°)	89.9°(103°/54.7°)	82.8°(51°)	139°	89.9°(103°)	82.8°(106°/51°)	89.9°(103°/54.7°)	92°(117.8°/109.4°)	100.5°
Day/Night	ICR	ICR	ICR	ICR	ICR	ICR	ICR	Electronic	Electronic
Max. IR Distance	30m (98ft), Smart IR	30m (98ft), Smart IR	20m (66ft), Smart IR	3m(10ft), Smart IR	20m (66ft), Smart IR	20m (66ft), Smart IR	20m (66ft), Smart IR	-	-
OSD Menu	Multi-language	Multi-language	Multi-language	Multi-language	Multi-language	Multi-language	Multi-language	Multi-language	Multi-language
WDR	DWDR	DWDR	DWDR	DWDR	DWDR	DWDR	DWDR	DWDR	DWDR
Noise Reduction	2D	2D	2D	2D	2D	2D	2D	2D	2D
Frame Rate	30fps@1080P 30/60fps@720P	30fps@1080P 30/60fps@720P	30fps@1080P 30/60fps@720P	30fps@1080P 30/60fps@720P	30fps@1080P 30/60fps@720P	30fps@1080P 30/60fps@720P	30fps@1080P 30/60fps@720P	30fps@1080P, 30/60fps@720P	30fps@1080P 30/60fps@720P
Video Output	HD/SD Switchable	HD/SD Switchable	HD/SD Switchable	HD/SD Switchable	HD/SD Switchable	HD/SD Switchable	HD/SD Switchable	HD/SD Switchable	HD/SD Switchable
Audio In	-	-	Built-in Mic	Built-in Mic	-	-	-	-	-
Alarm In/Out	-	-	-	-	-	-	-	-	-
Pan/Tilt/ Rotation	Pan: 0°~360°; Tilt: 0°~90° Rotation: 0°~360°	Pan: 0°~360°; Tilt: 0°~90° Rotation: 0°~360°	Pan: 0°~360°; Tilt: 0°~80° Rotation: 0°~360°	Pan: 0°~40°; Tilt: 0°~55° Rotation: 0°~360°	Pan: 0°~360°; Tilt: 0°~90° Rotation: 0°~360°	Pan: 0°~360°; Tilt: 0°~90° Rotation: 0°~360°	Pan: 0°~360°; Tilt: 0°~90° Rotation: 0°~360°	Pan:0°~360°; Tilt: 0°~90° Rotation: 0°~360°(-B)	Pan:0°~360°; Tilt: 0°~90° Rotation: 0°~360°
Ingress Protection	IP67	IP67	IP67	-	IP67	-	-	IP67	-
Working Temperature	-40°C~+60°C (-40°F ~ +140°F)	-40°C~+60°C (-40°F ~ +140°F)	-40°C~+60°C (-40°F ~ +140°F)	-40°C~+60°C (-40°F ~ +140°F)	-40°C~+60°C (-40°F ~ +140°F)	-40°C~+60°C (-40°F ~ +140°F)	-40°C~+60°C (-40°F ~ +140°F)	-40°C~+60°C (-40°F ~ +140°F)	-40°C~+60°C (-40°F ~ +140°F)
Power	DC12V±25% Max. 2.8W	DC12V±25% Max. 3.2W	DC12V±25% Max 2.9W	DC12V±25% Max. 1.5W	DC12V±25% Max. 3.2W	DC12V±25% Max. 2.8W	DC12V±25% Max. 3.2W	DC12V±25% Max. 0.6W	DC12V±25% Max. 0.6W

HDCVI CAMERAS







Lite Series

720P

Model	HAC-HFW1100R-VF-IRE6	HAC-HFW1100R-VF	HAC-HDBW1100R-VF	HAC-HDW1100R-VF	HAC-HFW1100D	HAC-HFW1100B
Appearance	 Cannon	 Cannon	 Cannon	 Cannon	 Cannon	 Cannon
Image Sensor	1/3" 1MP CMOS	1/3" 1MP CMOS	1/3" 1MP CMOS	1/3" 1MP CMOS	1/3" 1MP CMOS	1/3" 1MP CMOS
Min. Illumination	0.05Lux/F1.3 (Color) 0Lux/F1.3 (IR On)	0.05Lux/F1.3 (Color) 0Lux/F1.3 (IR On)	0.05Lux/F1.3 (Color) 0Lux/F1.3 (IR On)	0.05Lux/F1.3 (Color) 0Lux/F1.3 (IR On)	0.05Lux/F2.0 (Color) 0Lux/F2.0 (IR On)	0.05Lux/F2.0 (Color) 0Lux/F2.0 (IR On)
Lens	2.7~13.5mm, Manual	2.7~13.5mm, Manual	2.7~13.5mm, Manual	2.7~13.5mm, Manual	3.6mm (6mm, 8mm Optional)	3.6mm (2.8mm, 6mm, 8mm Optional)
FOV-H	91°~25°	91°~25°	91°~25°	91°~25°	72.3°(46°/34.8°)	72.3°(91.6°/46°/34.8°)
Day/Night	ICR	ICR	ICR	ICR	ICR	ICR
Max. IR Distance	60m (197ft), Smart IR	30m (98ft), Smart IR	30m (98ft), Smart IR	30m (98ft), Smart IR	80m (262ft), Smart IR	50m (164ft), Smart IR
OSD Menu	Multi-language	Multi-language	Multi-language	Multi-language	Multi-language	Multi-language
WDR	DWDR	DWDR	DWDR	DWDR	DWDR	DWDR
Noise Reduction	2D	2D	2D	2D	2D	2D
Frame Rate	30fps@720P	30fps@720P	30fps@720P	30fps@720P	30fps@720P	30fps@720P
Video Output	HD/SD Switchable	HD/SD Switchable	HD/SD Switchable	HD/SD Switchable	HD/SD Switchable	HD/SD Switchable
Audio In	-	-	-	-	-	-
Alarm In/Out	-	-	-	-	-	-
Pan/Tilt/Rotation	Pan: 0°~360°; Tilt: 0°~87° Rotation: 0°~360°	Pan: 0°~360°; Tilt: 0°~87° Rotation: 0°~360°	Pan: 0°~355°; Tilt: 0°~75° Rotation: 0°~355°	Pan: 0°~360°; Tilt: 0°~90° Rotation: 0°~360°	Pan: 0°~360°; Tilt: 0°~87° Rotation: 0°~360°	Pan: 0°~360°; Tilt: 0°~87° Rotation: 0°~360°
Ingress Protection	IP67	IP67	IP67, IK10	IP67	IP67	IP67
Working Temperature	-40°C~+60°C (-40°F ~ +140°F)	-40°C~+60°C (-40°F ~ +140°F)	-40°C~+60°C (-40°F ~ +140°F)	-40°C~+60°C (-40°F ~ +140°F)	-40°C~+60°C (-40°F ~ +140°F)	-40°C~+60°C (-40°F ~ +140°F)
Power	DC12V±25% Max. 7W	DC12V±25% Max. 3W	DC12V±25% Max. 2.9W	DC12V±25% Max. 3W	DC12V±25% Max. 4.6W	DC12V±25% Max. 3.5W

Lite Series









720P

Model	HAC-HFW1100S	HAC-HFW1000S	HAC-HFW1100SL	HAC-HFW1000SL	HAC-HFW1100RM	HAC-HFW1000RM
Appearance	 Cannon	 Cannon	 Cannon	 Cannon	 Cannon	 Cannon
Image Sensor	1/3" 1MP CMOS	1/4" 1MP CMOS	1/3" 1MP CMOS	1/4" 1MP CMOS	1/3" 1MP CMOS	1/4" 1MP CMOS
Min. Illumination	0.05Lux/F2.0 (Color) 0Lux/F2.0 (IR On)	0.05Lux/F2.0 (Color) 0Lux/F2.0 (IR On)	0.05Lux/F2.0 (Color) 0Lux/F2.0 (IR On)	0.05Lux/F2.0 (Color) 0Lux/F2.0 (IR On)	0.05Lux/F2.0 (Color) 0Lux/F2.0 (IR On)	0.05Lux/F2.0 (Color) 0Lux/F2.0 (IR On)
Lens	3.6mm (2.8mm, 6mm, Optional)	3.6mm (2.8mm Optional)	3.6mm (2.8mm, 6mm Optional)	3.6mm (2.8mm Optional)	3.6mm (2.8mm, 6mm, Optional)	3.6mm (2.8mm Optional)
FOV-H	72.3°(91.6°/46°)	60°(83.4°)	72.3°(91.6°/46°)	60°(83.4°)	72.3°(91.6°/46°)	60°(83.4°)
Day/Night	ICR	ICR	ICR	ICR	ICR	ICR
Max. IR Distance	30m (98ft), Smart IR	30m (98ft), Smart IR	30m (98ft), Smart IR	30m (98ft), Smart IR	20m (66ft), Smart IR	20m (66ft), Smart IR
OSD Menu	Multi-language	Multi-language	Multi-language	Multi-language	Multi-language	Multi-language
WDR	DWDR	DWDR	DWDR	DWDR	DWDR	DWDR
Noise Reduction	2D	2D	2D	2D	2D	2D
Frame Rate	30fps@720P	30fps@720P	30fps@720P	30fps@720P	30fps@720P	30fps@720P
Video Output	HD/SD Switchable	HD/SD Switchable	HD/SD Switchable	HD/SD Switchable	HD/SD Switchable	HD/SD Switchable
Audio In	-	-	-	-	-	-
Alarm In/Out	-	-	-	-	-	-
Pan/Tilt/Rotation	Pan: 0°~360°; Tilt: 0°~90° Rotation: 0°~360°	Pan: 0°~360°; Tilt: 0°~90° Rotation: 0°~360°	Pan: 0°~360°; Tilt: 0°~90° Rotation: 0°~360°	Pan: 0°~360°; Tilt: 0°~90° Rotation: 0°~360°	Pan: 0°~360°; Tilt: 0°~90° Rotation: 0°~360°	Pan: 0°~360°; Tilt: 0°~90° Rotation: 0°~360°
Ingress Protection	IP67	IP67	IP67	IP67	IP67	IP67
Working Temperature	-40°C~+60°C (-40°F ~ +140°F)	-40°C~+60°C (-40°F ~ +140°F)	-40°C~+60°C (-40°F ~ +140°F)	-40°C~+60°C (-40°F ~ +140°F)	-40°C~+60°C (-40°F ~ +140°F)	-40°C~+60°C (-40°F ~ +140°F)
Power	DC12V±25% Max. 3.8W	DC12V±25% Max. 3.8W	DC12V±25% Max. 3.8W	DC12V±25% Max. 3.8W	DC12V±25% Max. 2.8W	DC12V±25% Max. 2.8W

HDCVI CAMERAS

Lite Series

720P

Model	HAC-HFW1100R	HAC-HFW1000R	HAC-HDBW1100E	HAC-HDW1100EM(-A)	HAC-HDW1100M	HAC-HDW1000M	HAC-HDW1100R	HAC-HDW1000R
Appearance	 Cannon	 Cannon	 Cannon	 Cannon	 Cannon	 Cannon	 Cannon	 Cannon
Image Sensor	1/3" 1MP CMOS	1/4" 1MP CMOS	1/3" 1MP CMOS	1/3" 1MP CMOS	1/3" 1MP CMOS	1/4" 1MP CMOS	1/3" 1MP CMOS	1/4" 1MP CMOS
Min. Illumination	0.05Lux/F2.0 (Color) 0Lux/F2.0 (IR On)	0.05Lux/F2.0 (Color) 0Lux/F2.0 (IR On)	0.05Lux/F2.0 (Color) 0Lux/F2.0 (IR On)	0.05Lux/F2.0 (Color) 0Lux/F2.0 (IR On)	0.05Lux/F2.0 (Color) 0Lux/F2.0 (IR On)	0.05Lux/F2.0 (Color) 0Lux/F2.0 (IR On)	0.05Lux/F2.0 (Color) 0Lux/F2.0 (IR On)	0.05Lux/F2.0 (Color) 0Lux/F2.0 (IR On)
Lens	3.6mm (2.8mm, 6mm, Optional)	3.6mm (2.8mm Optional)	3.6mm (2.8mm, 6mm Optional)	3.6mm (2.8mm, 6mm Optional)	3.6mm (2.8mm, 6mm Optional)	3.6mm (2.8mm Optional)	3.6mm (2.8mm, 6mm Optional)	3.6mm (2.8mm Optional)
FOV-H	72.3°(91.6°/46°)	60°(83.4°)	72.3°(91.6°/46°)	72.3°(91.6°/46°)	72.3°(91.6°/46°)	60°(83.4°)	72.3°(91.6°/46°)	60°(83.4°)
Day/Night	ICR	ICR	ICR	ICR	ICR	ICR	ICR	ICR
Max. IR Distance	20m (66ft), Smart IR	20m (66ft), Smart IR	30m (98ft), Smart IR	50m (164ft), Smart IR	30m (98ft), Smart IR	30m (98ft), Smart IR	20m (66ft), Smart IR	20m (66ft), Smart IR
OSD Menu	Multi-language	Multi-language	Multi-language	Multi-language	Multi-language	Multi-language	Multi-language	Multi-language
WDR	DWDR	DWDR	DWDR	DWDR	DWDR	DWDR	DWDR	DWDR
Noise Reduction	2D	2D	2D	2D	2D	2D	2D	2D
Frame Rate	30fps@720P	30fps@720P	30fps@720P	30fps@720P	30fps@720P	30fps@720P	30fps@720P	30fps@720P
Video Output	HD/SD Switchable	HD/SD Switchable	HD/SD Switchable	HD/SD Switchable	HD/SD Switchable	HD/SD Switchable	HD/SD Switchable	HD/SD Switchable
Audio In	-	-	-	Built-in Mic(-A)	-	-	-	-
Alarm In/Out	-	-	-	-	-	-	-	-
Pan/Tilt/Rotation	Pan: 0°~360°; Tilt: 0°~90° Rotation: 0°~360°	Pan: 0°~360°; Tilt: 0°~90° Rotation: 0°~360°	Pan: 0°~355°; Tilt: 0°~65° Rotation: 0°~355°	Pan: 0°~360°; Tilt: 0°~78° Rotation: 0°~360°	Pan: 0°~360°; Tilt: 0°~90° Rotation: 0°~360°	Pan: 0°~360°; Tilt: 0°~90° Rotation: 0°~360°	Pan: 0°~360°; Tilt: 0°~90° Rotation: 0°~360°	Pan: 0°~360°; Tilt: 0°~90° Rotation: 0°~360°
Ingress Protection	IP67	IP67	IP67, IK10	IP67	IP67	IP67	-	-
Working Temperature	-40°C~+60°C (-40°F ~ +140°F)	-40°C~+60°C (-40°F ~ +140°F)	-40°C~+60°C (-40°F ~ +140°F)	-40°C~+60°C (-40°F ~ +140°F)	-40°C~+60°C (-40°F ~ +140°F)	-40°C~+60°C (-40°F ~ +140°F)	-40°C~+60°C (-40°F ~ +140°F)	-40°C~+60°C (-40°F ~ +140°F)
Power	DC12V±25% Max. 2.8W	DC12V±25% Max. 2.8W	DC12V±25% Max. 2.4W	DC12V±25% Max. 2.9W	DC12V±25% Max. 2.8W	DC12V±25% Max. 2.8W	DC12V±25% Max. 2.8W	DC12V±25% Max. 2.8W

HDCVI CAMERAS

IoT Series

HDCVI-IoT series provides users with a multi-dimensional system that links video with audio, sensing info and alarms to verify potential risks, thus securing personnel and property safety with greatly reduced false alarms.

⊕ KEY FEATURES

Video Linkage

Multiple sensors linked together with video for verification and real-time alarm.

Accurate Detection







HDCVI video surveillance with PIR ensures important events are seen.

Everything-over-Coax

Multiple data types can be transmitted over a single coax cable

IoT Overlay

Real-time temperature & humidity info from sensors overlaid on video to improve efficiency

IoT Series		LinCa		MotionEye			
Model	HAC-LC1220T-TH	HAC-LC1200SL-W	HAC-ME2802B-PIR	HAC-ME1400B-PIR	HAC-ME1200B-PIR	HAC-HUM1220A	HAC-HUM1220A-W
Appearance							
Image Sensor	1/2.9" 2MP CMOS	1/2.7" 2MP CMOS	1/2" 8MP CMOS	1/3" 4MP CMOS	1/2.7" 2MP CMOS	1/2.9" 2MP CMOS	1/2.9" 2MP CMOS
Min. Illumination	0.02Lux/F2.0 (Color) 0Lux/F2.0 (IR On)	0.02Lux/F2.0 (Color) 0Lux/F2.0 (IR On)	0.005Lux/F1.6 (Color) 0Lux/F1.6 (IR On)	0.03Lux/F2.0 (Color) 0Lux/F2.0 (IR On)	0.02Lux/F2.0 (Color) 0Lux/F2.0 (IR On)	0.02Lux/F2.0 (Color) 0.002Lux/F2.0 (B/W)	0.02Lux/F2.0 (Color) 0.002Lux/F2.0 (B/W)
Lens	3.6mm (2.8mm, 6mm Optional)	3.6mm (2.8mm, 6mm Optional)	2.8mm	2.8mm	2.8mm	2.8mm	2.8mm
FOV-H	82.8°(104°/51°)	89.9°(112°/54.7°)	110.8°	107.2°	112°	100.5°	100.5°
Day/Night	ICR	ICR	ICR	ICR	ICR	Electronic	Electronic
Max. IR Distance	20m (66ft), Smart IR	30m (98ft), Smart IR	20m (66ft), Smart IR	20m (66ft), Smart IR	20m (66ft), Smart IR	-	-
OSD Menu	Multi-language	Multi-language	Multi-language	Multi-language	Multi-language	Multi-language	Multi-language
WDR	DWDR	DWDR	DWDR	DWDR	DWDR	DWDR	DWDR
Noise Reduction	2D	2D	2D	2D	2D	2D	2D
Frame Rate	30fps@1080P 30/60fps@720P	30fps@1080P 30/60fps@720P	15fps@4K 20fps@6MP 30fps@4MP	30fps@4MP 30fps@1080P 30fps@720P	30fps@1080P 30/60fps@720P	30fps@1080P 30/60fps@720P	30fps@1080P 30/60fps@720P
Video Output	HD/SD Switchable (Video only)	HD/SD Switchable (Video only)	HD/SD Switchable (Video only)	HD/SD Switchable (Video only)	HD/SD Switchable (Video only)	HD/SD Switchable (Video only)	HD/SD Switchable (Video only)
IoT Features	Built-in Temperature & Humidity Sensor Detection Range: -40°C~+60°C (-40°F ~ +140°F) & 10-95%RH	Built-in Airfly Tranceiver Up to 32 Wireless Devices Connection Transmission Range up to 100m (Open Space)	Accurate Alarm Based on PIR & Motion Dual-detection Coax Alarm Out	Accurate Alarm Based on PIR & Motion Dual-detection Coax Alarm Out	Accurate Alarm Based on PIR & Motion Dual-detection Coax Alarm Out	Built-in PIR Coax Alarm Out	Built-in PIR Coax & Wireless Alarm Out
Pan/Tilt/Rotation	Pan: 0°~360° Tilt: 0°~90° Rotation: 0°~360°	Pan: 0°~360° Tilt: 0°~90° Rotation: 0°~360°	Pan: 0°~360° Tilt: 0°~90° Rotation: 0°~360°	Pan: 0°~360° Tilt: 0°~90° Rotation: 0°~360°	Pan: 0°~360° Tilt: 0°~90° Rotation: 0°~360°	Pan: 0°~180° Tilt: 0°~180° Rotation: 0°~360°	Pan: 0°~180° Tilt: 0°~180° Rotation: 0°~360°
Ingress Protection	IP67	IP67	IP67	IP67	IP67	-	-
Working Temperature	-40°C~+60°C (-40°F ~ +140°F)	-40°C~+60°C (-40°F ~ +140°F)	-10°C~+50°C (14°F ~ +122°F)	-10°C~+50°C (14°F ~ +122°F)	-10°C~+50°C (14°F ~ +122°F)	-10°C~+50°C (14°F ~ +122°F)	-10°C~+50°C (14°F ~ +122°F)
Power	DC12V±25% Max. 3.4W	DC12V±25% Max. 4.4W	DC12V±30% Max. 5.3W	DC12V±30% Max. 4.4W	DC12V±30% Max.4.1W	DC12V±25% Max. 0.7W	DC12V±25% Max. 0.7W

HDCVI PTZ CAMERAS



HDCVI PTZ CAMERAS

Ultra Series

The Ultra Series PTZ is designed for projects with the most demanding quality and performance requirements. With high performance Sony camera sensors, IP67, and IK10, this range is capable of handling any type of scenario.

⊕ KEY FEATURES

Advanced Sensors

High performance Sony sensors deliver high quality and reliability

Superior Image

Starlight / 120db WDR provides clear image under any light conditions

Super IR Range



Cameras provide up to 200m IR range for performance in dark environments

Powerful Protection

IP67 / IK10 ratings ensures cameras can withstand tough conditions

Ultra Series

1080P

Model	SD6AE230IA-HC	SD65F230IA-HC
Appearance	 starlight	 starlight
Image Sensor	1/1.9" 2MP CMOS	1/1.9" 2MP CMOS
Min. Illumination	0.002Lux/F1.6(Color) 0Lux/F1.6 (IR on)	0.002Lux/F1.6(Color) 0.0002Lux/F1.6 (B/W)
Lens	6~180mm (30x Optical zoom)	6~180mm (30x Optical zoom)
FOV-H	61.2° ~ 2.1°	61.2° ~ 2.1°
Day/Night	ICR	ICR
Max. IR Distance	200m(656ft)	-
OSD Menu	Supported	Supported
WDR	120dB True WDR	120dB True WDR
Noise Reduction	2D/3D	2D/3D
Frame Rate	30fps@1080P 30/60fps@720P	30fps@1080P 30/60fps@720P
Video Output	HD/SD Switchable	HD/SD Switchable
Pan/Tilt	Pan: 0° ~ 360° endless; Tilt: -20° ~ 90°	Pan: 0° ~ 360° endless; Tilt: -20° ~ 90°
Preset Speed	Pan: 240° /s Tilt: 200° /s	Pan: 600° /s Tilt: 500° /s
Audio In	1	1
Alarm In/Out	2/1	2/1
Ingress Protection	IP67,IK10	IP67,IK10
Working Temperature	-40°C~+70°C (-40°F~+158°F)	-40°C~+70°C (-40°F~+158°F)
Power	AC24V Max. 38W	AC24V Max. 20W

HDCVI PTZ CAMERAS

Pro Series

The Pro Series PTZ is designed to meet high image quality and low-light surveillance requirements with the help of Starlight technology. Rich housing and model selections are available to meet diverse application needs.

⊕ KEY FEATURES

Great Selection

Wide range of housings and models to suit all requirements

Optimized Image

High quality image with Starlight technology

Long IR Range





Cameras provide up to 150m IR range for performance in dark environments

Powerful Protection

IP66 / IP67 / IK10 ratings ensures cameras can withstand tough conditions

Pro Series

4MP

Model	SD6C430I-HC	SD60430I-HC	SD59430I-HC	SD50430I-HC	SD52C430I-HC
Appearance					
Image Sensor	1/3" 4MP CMOS	1/3" 4MP CMOS	1/3" 4MP CMOS	1/3" 4MP CMOS	1/3" 4MP CMOS
Min. Illumination	0.05Lux/F1.6(Color) 0Lux/F1.6 (IR on)	0.05Lux/F1.6(Color) 0.005Lux/F1.6 (B/W)	0.05Lux/F1.6(Color) 0Lux/F1.6 (IR on)	0.05Lux/F1.6(Color) 0.005Lux/F1.6 (B/W)	0.05Lux/F1.6(Color) 0.005Lux/F1.6 (B/W)
Lens	4.5~135mm (30x Optical zoom)	4.5~135mm (30x Optical zoom)	4.5~135mm (30x Optical zoom)	4.5~135mm (30x Optical zoom)	4.5~135mm (30x Optical zoom)
FOV-H	60° ~ 2.2°	60° ~ 2.2°	60° ~ 2.2°	60° ~ 2.2°	60° ~ 2.2°
Day/Night	ICR	ICR	ICR	ICR	ICR
Max. IR Distance	100m(328ft)	-	100m(328ft)	-	-
OSD Menu	Supported	Supported	Supported	Supported	Supported
WDR	120dB True WDR	120dB True WDR	120dB True WDR	120dB True WDR	120dB True WDR
Noise Reduction	2D/3D	2D/3D	2D/3D	2D/3D	2D/3D
Frame Rate	30fps@4MP/1080P 30/60fps@720P	30fps@4MP/1080P 30/60fps@720P	30fps@4MP/1080P 30/60fps@720P	30fps@4MP/1080P 30/60fps@720P	30fps@4MP/1080P 30/60fps@720P
Video Output	HD/SD Switchable	HD/SD Switchable	HD/SD Switchable	HD/SD Switchable	HD/SD Switchable
Pan/Tilt	Pan: 0° ~ 360° endless; Tilt: -15° ~ 90°	Pan: 0° ~ 360° endless Tilt: -20° ~ 90°	Pan: 0° ~ 360° endless Tilt: -15° ~ 90°	Pan: 0° ~ 360° endless Tilt: 0° ~ 90°	Pan: 0° ~ 360° endless Tilt: 0° ~ 90°
Preset Speed	Pan: 240° /s; Tilt: 200° /s	Pan: 600° /s; Tilt: 500° /s	Pan: 400° /s; Tilt: 300° /s	Pan: 500° /s; Tilt: 500° /s	Pan: 500° /s; Tilt: 500° /s
Audio In	1	1	1	1	1
Alarm In/Out	2/1	2/1	2/1	2/1	2/1
Ingress Protection	IP66	IP67, IK10	IP66	IP67, IK10	IK10
Working Temperature	-40°C~+60°C (-40°F~+140°F)	-40°C~+70°C (-40°F~+158°F)	-40°C~+70°C (-40°F~+158°F)	-40°C~+60°C (-40°F~+140°F)	-30°C~+60°C (-22°F~+140°F)
Power	AC24V Max. 26W	AC24V Max. 20W	AC24V Max. 23W	AC24V Max. 23W	AC24V Max. 13W

HDCVI PTZ CAMERAS







Pro Series

1080P

Model	SD6C230I-HC(-S3)	SD6C225I-HC(-S3)	SD60230I-HC(-S3)	SD60225I-HC(-S3)	SD59230I-HC(-S3)	SD59225I-HC(-S3)	SD50230I-HC(-S3)	SD50225I-HC(-S3)
Appearance	 starlight	 starlight	 starlight	 starlight	 starlight	 starlight	 starlight	 starlight
Image Sensor	1/2.8" 2MP STARVIS™ CMOS	1/2.8" 2MP STARVIS™ CMOS	1/2.8" 2MP STARVIS™ CMOS	1/2.8" 2MP STARVIS™ CMOS	1/2.8" 2MP STARVIS™ CMOS	1/2.8" 2MP STARVIS™ CMOS	1/2.8" 2MP STARVIS™ CMOS	1/2.8" 2MP STARVIS™ CMOS
Min. Illumination	0.005Lux/F1.6 (Color) 0Lux/F1.6 (IR on)	0.005Lux/F1.6 (Color) 0Lux/F1.6 (IR on)	0.005Lux/F1.6 (Color) 0.0005Lux/F1.6 (B/W)	0.005Lux/F1.6 (Color) 0.0005Lux/F1.6 (B/W)	0.005Lux/F1.6 (Color) 0Lux/F1.6 (IR on)	0.005Lux/F1.6 (Color) 0Lux/F1.6 (IR on)	0.005Lux/F1.6 (Color) 0.0005Lux/F1.6 (B/W)	0.005Lux/F1.6 (Color) 0.0005Lux/F1.6 (B/W)
Lens	4.5~135mm (30x Optical zoom)	4.8~120mm (25x Optical zoom)	4.5~135mm (30x Optical zoom)	4.8~120mm (25x Optical zoom)	4.5~135mm (30x Optical zoom)	4.8~120mm (25x Optical zoom)	4.5~135mm (30x Optical zoom)	4.8~120mm (25x Optical zoom)
FOV-H	67.8° ~ 2.4°	59.2° ~ 2.4°	67.8° ~ 2.4°	59.2° ~ 2.4°	67.8° ~ 2.4°	59.2° ~ 2.4°	67.8° ~ 2.4°	59.2° ~ 2.4°
Day/Night	ICR	ICR	ICR	ICR	ICR	ICR	ICR	ICR
Max. IR Distance	150m(492ft)	150m(492ft)	-	-	150m(492ft)	150m(492ft)	-	-
OSD Menu	Supported	Supported	Supported	Supported	Supported	Supported	Supported	Supported
WDR	120dB True WDR	120dB True WDR	120dB True WDR	120dB True WDR	120dB True WDR	120dB True WDR	120dB True WDR	120dB True WDR
Noise Reduction	2D/3D	2D/3D	2D/3D	2D/3D	2D/3D	2D/3D	2D/3D	2D/3D
Frame Rate	30fps@1080P 30/60fps@720P	30fps@1080P 30/60fps@720P	30fps@1080P 30/60fps@720P	30fps@1080P 30/60fps@720P	30fps@1080P 30/60fps@720P	30fps@1080P 30/60fps@720P	30fps@1080P 30/60fps@720P	30fps@1080P 30/60fps@720P
Video Output	HD/SD Switchable	HD/SD Switchable	HD/SD Switchable	HD/SD Switchable	HD/SD Switchable	HD/SD Switchable	HD/SD Switchable	HD/SD Switchable
Pan/Tilt	Pan: 0° ~ 360° endless Tilt: -15° ~ 90°	Pan: 0° ~ 360° endless; Tilt: -15° ~ 90°	Pan: 0° ~ 360° endless; Tilt: -20° ~ 90°	Pan: 0° ~ 360° endless; Tilt: -20° ~ 90°	Pan: 0° ~ 360° endless; Tilt: -15° ~ 90°	Pan: 0° ~ 360° endless; Tilt: -15° ~ 90°	Pan: 0° ~ 360° endless; Tilt: 0° ~ 90°	Pan: 0° ~ 360° endless; Tilt: 0° ~ 90°
Preset Speed	Pan: 240°/s Tilt: 200°/s	Pan: 240°/s Tilt: 200°/s	Pan: 600°/s Tilt: 500°/s	Pan: 600°/s Tilt: 500°/s	Pan: 400°/s Tilt: 300°/s	Pan: 400°/s Tilt: 300°/s	Pan: 500°/s Tilt: 500°/s	Pan: 500°/s Tilt: 500°/s
Audio In	1	1	1	1	1	1	1	1
Alarm In/Out	2/1	2/1	2/1	2/1	2/1	2/1	2/1	2/1
Ingress Protection	IP66	IP66	IP67, IK10	IP67, IK10	IP66	IP66	IP67, IK10	IP67, IK10
Working Temperature	-40°C ~ +60°C (-40°F ~ +140°F)	-40°C ~ +60°C (-40°F ~ +140°F)	-40°C ~ +70°C (-40°F ~ +158°F)	-40°C ~ +70°C (-40°F ~ +158°F)	-40°C ~ +70°C (-40°F ~ +158°F)	-40°C ~ +70°C (-40°F ~ +158°F)	-40°C ~ +60°C (-40°F ~ +140°F)	-40°C ~ +60°C (-40°F ~ +140°F)
Power	AC24V Max. 26W	AC24V Max. 26W	AC24V Max. 20W	AC24V Max. 20W	AC24V Max. 23W	AC24V Max. 23W	AC24V Max. 23W	AC24V Max. 23W

HDCVI PTZ CAMERAS

Pro Series

	1080P		720P				
Model	SD52C230I-HC(-S3)	SD52C225I-HC(-S3)	SD6C131I-HC(-S3)	SD60131I-HC(-S3)	SD59131I-HC(-S3)	SD50131I-HC(-S3)	SD52C131I-HC(-S3)
Appearance	 starlight	 starlight	 starlight	 starlight	 starlight	 starlight	 starlight
Image Sensor	1/2.8" 2MP STARVIS™ CMOS	1/2.8" 2MP STARVIS™ CMOS	1/2.8" STARVIS™ CMOS	1/2.8" STARVIS™ CMOS	1/2.8" STARVIS™ CMOS	1/2.8" STARVIS™ CMOS	1/2.8" STARVIS™ CMOS
Min. Illumination	0.005Lux/F1.6 (Color) 0.0005Lux/F1.6 (B/W)	0.005Lux/F1.6 (Color) 0.0005Lux/F1.6 (B/W)	0.005Lux/F1.6 (Color) 0Lux/F1.6 (IR on)	0.005Lux/F1.6 (Color) 0.0005Lux/F1.6 (B/W)	0.005Lux/F1.6 (Color) 0Lux/F1.6 (IR on)	0.005Lux/F1.6 (Color) 0.0005Lux/F1.6 (B/W)	0.005Lux/F1.6 (Color) 0.0005Lux/F1.6 (B/W)
Lens	4.5~135mm (30x Optical zoom)	4.8~120mm (25x Optical zoom)	4.8~150mm (31x Optical zoom)	4.8~150mm (31x Optical zoom)	4.8~150mm (31x Optical zoom)	4.8~150mm (31x Optical zoom)	4.8~150mm (31x Optical zoom)
FOV-H	67.8° ~ 2.4°	59.2° ~ 2.4°	58.3° ~ 1.9°	58.3° ~ 1.9°	58.3° ~ 1.9°	58.3° ~ 1.9°	58.3° ~ 1.9°
Day/Night	ICR	ICR	ICR	ICR	ICR	ICR	ICR
Max. IR Distance	-	-	150m(492ft)	-	150m(492ft)	-	-
OSD Menu	Supported	Supported	Supported	Supported	Supported	Supported	Supported
WDR	120dB True WDR	120dB True WDR	120dB True WDR	120dB True WDR	120dB True WDR	120dB True WDR	120dB True WDR
Noise Reduction	2D/3D	2D/3D	2D/3D	2D/3D	2D/3D	2D/3D	2D/3D
Frame Rate	30fps@1080P 30/60fps@720P	30fps@1080P 30/60fps@720P	30/60fps@720P	30/60fps@720P	30/60fps@720P	30/60fps@720P	30/60fps@720P
Video Output	HD/SD Switchable	HD/SD Switchable	HD/SD Switchable	HD/SD Switchable	HD/SD Switchable	HD/SD Switchable	HD/SD Switchable
Pan/Tilt	Pan: 0° ~ 360° endless; Tilt: 0° ~ 90°	Pan: 0° ~ 360° endless; Tilt: 0° ~ 90°	Pan: 0° ~ 360° endless; Tilt: -15° ~ 90°	Pan: 0° ~ 360° endless; Tilt: -20° ~ 90°	Pan: 0° ~ 360° endless; Tilt: -15° ~ 90°	Pan: 0° ~ 360° endless; Tilt: 0° ~ 90°	Pan: 0° ~ 360° endless; Tilt: 0° ~ 90°
Preset Speed	Pan: 500°/s Tilt: 500°/s	Pan: 500°/s Tilt: 500°/s	Pan: 240°/s Tilt: 200°/s	Pan: 600°/s Tilt: 500°/s	Pan: 400°/s Tilt: 300°/s	Pan: 500°/s Tilt: 500°/s	Pan: 500°/s Tilt: 500°/s
Audio In	1	1	1	1	1	1	1
Alarm In/Out	2/1	2/1	2/1	2/1	2/1	2/1	2/1
Ingress Protection	IK10	IK10	IP66	IP67, IK10	IP66	IP67, IK10	IK10
Working Temperature	-30°C ~ +60°C (-22°F ~ +140°F)	-30°C ~ +60°C (-22°F ~ +140°F)	-40°C ~ +60°C (-40°F ~ +140°F)	-40°C ~ +70°C (-40°F ~ +158°F)	-40°C ~ +70°C (-40°F ~ +158°F)	-40°C ~ +60°C (-40°F ~ +140°F)	-30°C ~ +60°C (-22°F ~ +140°F)
Power	AC24V Max. 13W	AC24V Max. 13W	AC24V Max. 26W	AC24V Max. 20W	AC24V Max. 23W	AC24V Max. 23W	AC24V Max. 13W

HDCVI PTZ CAMERAS

HDCVI PTZ CAMERAS

Lite Series

The Lite Series PTZ offers a cost/performance solution suitable for a range of applications. Its compact design built with Dahua quality standards and assurance enables the entire range to meet your requirements.

⊕ KEY FEATURES

Compact Design

Small PTZ cameras;
Can fit in a number of places

Mini IR PTZ

Pan / tilt / zoom and IR functionality in compact housing

Cost-Effective



Performance and quality are combined at an affordable price

Powerful Zoom

Up to 31x optical zoom easily covers large areas





Lite Series

1080P

Model	SD49225I-HC(-S3)	SD49212I-HC(-S3)	SD40212I-HC(-S3)
Appearance	 starlight	 starlight	 starlight
Image Sensor	1/2.8" 2MP STARVIS™ CMOS	1/2.8" 2MP STARVIS™ CMOS	1/2.8" 2MP STARVIS™ CMOS
Min. Illumination	0.005Lux/F1.6 (Color) 0Lux/F1.6 (IR on)	0.005Lux/F1.6(Color) 0Lux/F1.6(IR on)	0.005Lux/F1.6 (Color) 0.0005Lux/F1.6 (B/W)
Lens	4.8~120mm (25x Optical zoom)	5.3~64mm (12x Optical zoom)	5.3~64mm (12x Optical zoom)
FOV-H	59.2° ~ 2.4°	58.2° ~ 4.8°	58.2° ~ 4.8°
Day/Night	ICR	ICR	ICR
Max. IR Distance	100m(328ft)	100m(328ft)	-
OSD Menu	Supported	Supported	Supported
WDR	120dB True WDR	120dB True WDR	120dB True WDR
Noise Reduction	2D/3D	2D/3D	2D/3D
Frame Rate	30fps@1080P 30/60fps@720P	30fps@1080P 30/60fps@720P	30fps@1080P 30/60fps@720P
Video Output	HD/SD Switchable	HD/SD Switchable	HD/SD Switchable
Pan/Tilt	Pan: 0° ~ 360° endless Tilt: -15° ~ 90°	Pan: 0° ~ 360° endless Tilt: -15° ~ 90°	Pan: 0° ~ 360° endless Tilt: -2° ~ 90°
Preset Speed	Pan: 240°/s Tilt: 200°/s	Pan: 240°/s Tilt: 200°/s	Pan: 300°/s Tilt: 200°/s
Audio In	1	1	1
Alarm In/Out	2/1	2/1	2/1
Ingress Protection	IP66	IP66	IP66, IK10
Working Temperature	-40°C ~ +70°C (-40°F ~ +158°F)	-40°C ~ +70°C (-40°F ~ +158°F)	-40°C ~ +60°C (-40°F ~ +140°F)
Power	DC12V Max. 20W	DC12V Max. 20W	AC24V Max. 19W

HDCVI PTZ CAMERAS

Lite Series

	1080P			720P				
Model	SD422121-HC(-S3)	SD42C2121-HC(-S3)	SD222041-GC	SD491311-HC(-S3)	SD491161-HC(-S3)	SD401161-HC(-S3)	SD421161-HC(-S3)	SD42C1161-HC(-S3)
Appearance	 starlight	 starlight		 starlight	 starlight	 starlight	 starlight	 starlight
Image Sensor	1/2.8" 2MP STARVIS™ CMOS	1/2.8" 2MP STARVIS™ CMOS	1/2.7" 2MP CMOS	1/2.8" STARVIS™ CMOS	1/2.8" STARVIS™ CMOS	1/2.8" STARVIS™ CMOS	1/2.8" STARVIS™ CMOS	1/2.8" STARVIS™ CMOS
Min. Illumination	0.005Lux/F1.6 (Color) 0.0005Lux/F1.6 (B/W)	0.005Lux/F1.6 (Color) 0.0005Lux/F1.6 (B/W)	0.05Lux/F1.6 (Color) 0.005Lux/F1.6 (B/W)	0.005Lux/F1.6(Color) 0Lux/F1.6 (IR on)	0.005Lux/F1.6(Color) 0Lux/F1.6(IR on)	0.005Lux/F1.6(Color) 0.0005Lux/F1.6(B/W)	0.005Lux/F1.6(Color) 0.0005Lux/F1.6(B/W)	0.005Lux/F1.6(Color) 0.0005Lux/F1.6(B/W)
Lens	5.3~64mm (12x Optical zoom)	5.3~64mm (12x Optical zoom)	2.7~11mm (4x Optical zoom)	4.8~150mm (31x Optical zoom)	5.3~84.8mm (16x Optical zoom)	5.3~84.8mm (16x Optical zoom)	5.3~84.8mm (16x Optical zoom)	5.3~84.8mm (16x Optical zoom)
FOV-H	58.2° ~ 4.8°	58.2° ~ 4.8°	112.5° ~ 39°	58.3° ~ 1.9°	57.2° ~ 3.75°	57.2° ~ 3.75°	57.2° ~ 3.75°	57.2° ~ 3.75°
Day/Night	ICR	ICR	ICR	ICR	ICR	ICR	ICR	ICR
Max. IR Distance	-	-	-	100m(328ft)	100m(328ft)	-	-	-
OSD Menu	Supported	Supported	Supported	Supported	Supported	Supported	Supported	Supported
WDR	120dB True WDR	120dB True WDR	120dB True WDR	120dB True WDR	120dB True WDR	120dB True WDR	120dB True WDR	120dB True WDR
Noise Reduction	2D/3D	2D/3D	2D/3D	2D/3D	2D/3D	2D/3D	2D/3D	2D/3D
Frame Rate	30fps@1080P 30/60fps@720P	30fps@1080P 30/60fps@720P	30fps@1080P 30/60fps@720P	30/60fps@720P	30/60fps@720P	30/60fps@720P	30/60fps@720P	30/60fps@720P
Video Output	HD/SD Switchable	HD/SD Switchable	HD/SD Switchable	HD/SD Switchable	HD/SD Switchable	HD/SD Switchable	HD/SD Switchable	HD/SD Switchable
Pan/Tilt	Pan: 0° ~ 360° endless Tilt: -2° ~ 90°	Pan: 0° ~ 360° endless Tilt: -2° ~ 90°	Pan: 0° ~ 355° Tilt: 0° ~ 90°	Pan: 0° ~ 360° endless Tilt: -15° ~ 90°	Pan: 0° ~ 360° endless; Tilt: -15° ~ 90°	Pan: 0° ~ 360° endless; Tilt: -2° ~ 90°	Pan: 0° ~ 360° endless; Tilt: -2° ~ 90°	Pan: 0° ~ 360° endless; Tilt: -2° ~ 90°
Preset Speed	Pan: 300°/s Tilt: 200°/s	Pan: 300°/s Tilt: 200°/s	Pan: 100°/s Tilt: 60°/s	Pan: 240°/s Tilt: 200°/s	Pan: 240°/s Tilt: 200°/s	Pan: 300°/s Tilt: 200°/s	Pan: 300°/s Tilt: 200°/s	Pan: 300°/s Tilt: 200°/s
Audio In	1	1	-	1	1	1	1	1
Alarm In/Out	2/1	2/1	-	2/1	2/1	2/1	2/1	2/1
Ingress Protection	IP66, IK10	IK10	IP66, IK10	IP66	IP66	IP66, IK10	IP66, IK10	IK10
Working Temperature	-30°C ~ +60°C (-22°F ~ +140°F)	-30°C ~ +60°C (-22°F ~ +140°F)	-30°C ~ +60°C (-22°F ~ +140°F)	-40°C ~ +70°C (-40°F ~ +158°F)	-40°C ~ +70°C (-40°F ~ +158°F)	-40°C ~ +60°C (-40°F ~ +140°F)	-30°C ~ +60°C (-22°F ~ +140°F)	-30°C ~ +60°C (-22°F ~ +140°F)
Power	AC24V Max. 10W	AC24V Max. 10W	DC12V Max. 10W	DC12V Max. 20W	DC12V Max. 20W	AC24V Max. 19W	AC24V Max. 10W	AC24V Max. 10W

HDCVI RECORDERS



HDCVI RECORDERS

Pro Series

The Pro Series is a perfect choice for mid to large-scale business and projects where both high reliability and flexibility are required. With the adoption of Smart H.265+/H.265, the series can effectively improve encoding efficiency and save bandwidth/storage costs while ensuring video quality in high resolution (4MP / 4K) surveillance scenarios.

The series also supports advanced Point of Sale(POS) and Internet of Things (IoT) functions that make the system smarter and more convenient to use.

⊕ KEY FEATURES

H.265+/H.265

Improves encoding efficiency, reducing overall system cost

High Definition

Up to 4K resolution available

All-over-Coax

Coaxial audio/alarm/firmware upgrade

IoT

Achieves multi-dimensional security by integrating sensors with video

POS

POS ticket information overlay and search















Super Performance

Supports N+N channels IPC access, each channel up to 8MP input

Pro Series		
	8 HDD	4 HDD
Model	XVR7816S-4KL-X	XVR7416L-4KL-X
Appearance	 POS IoT	 POS IoT
Video Compression	H.265+/H.265/H.264+/H.264	H.265+/H.265/H.264+/H.264
Audio Compression	AAC/G.711/PCM	AAC/G.711/PCM
Video Standard	HDCVI/AHD/CVBS/TVI (Auto-detect)	HDCVI/AHD/CVBS/TVI (Auto-detect)
Max. Recording Resolution	CH01-16: 4K	CH01-16: 4K
Max. HDCVI Recording Rate	7fps@4K, 10fps@6MP 12fps@5MP, 15fps@4MP 15fps@3MP, 30fps@4M-N 30fps@1080P	7fps@4K, 10fps@6MP 12fps@5MP, 15fps@4MP 15fps@3MP, 30fps@4M-N 30fps@1080P
CVBS Input	16CH,1.0Vp-p,75Ω	16CH,1.0Vp-p,75Ω
IP Camera Input	16+16 Up to 8MP	16+16 Up to 8MP
Max IP Input/Record	128Mbps/128Mbps	128Mbps/128Mbps
Audio In/out	16/1, 2-way	4/1, 2-way
Max HDD	8x10TB	4x10TB
Display	HDMI 1(3840x2160) HDMI 2/VGA(1920x1080),TV	HDMI 1(3840x2160) HDMI 2/VGA(1920x1080),TV
eSATA	1	1
USB	2 USB 3.0, 2 USB 2.0	2 USB 3.0, 1 USB 2.0
DVD Burner	USB/SATA	USB/SATA
Alarm In/Out	16/6	16/6
Ethernet	2 Gigabit ports	1 Gigabit port
Remote User Login	128	128
Dimensions	440x455x95mm (17.3"x17.9"x3.7")	440x417x76mm (17.3"x16.9"x3.0")
Power	AC 100-240V,50/60Hz, ≤35W (Without HDD)	AC 100-240V,50/60Hz, ≤35W (Without HDD)
Intelligent Video	Tripwire,Intrusion, Abandoned/Missing, Face Detection	Tripwire,Intrusion, Abandoned/Missing, Face Detection
Star Features	IoT, POS, P2P Coaxial Audio/Alarm/Upgrade, 2D/3DNR	IoT, POS, P2P Coaxial Audio/Alarm/Upgrade, 2D/3DNR

HDCVI RECORDERS









Pro Series

	2 HDD			1 HDD			
Model	XVR7208A-4K-X	XVR7216A-4KL-X	XVR7208A-4KL-X	XVR7108HE-4K-X	XVR7116HE-4KL-X	XVR7108HE-4KL-X	XVR7104HE-4KL-X
Appearance	 	 	 	 	 	 	 
Video Compression	H.265+/H.265/H.264+/H.264	H.265+/H.265/H.264+/H.264	H.265+/H.265/H.264+/H.264	H.265+/H.265/H.264+/H.264	H.265+/H.265/H.264+/H.264	H.265+/H.265/H.264+/H.264	H.265+/H.265/H.264+/H.264
Audio Compression	AAC/G.711/PCM	AAC/G.711/PCM	AAC/G.711/PCM	AAC/G.711/PCM	AAC/G.711/PCM	AAC/G.711/PCM	AAC/G.711/PCM
Video Standard	HDCVI/AHD/CVBS/TVI (Auto-detect)	HDCVI/AHD/CVBS/TVI (Auto-detect)	HDCVI/AHD/CVBS/TVI (Auto-detect)	HDCVI/AHD/CVBS/TVI (Auto-detect)	HDCVI/AHD/CVBS/TVI (Auto-detect)	HDCVI/AHD/CVBS/TVI (Auto-detect)	HDCVI/AHD/CVBS/TVI (Auto-detect)
Max. Recording Resolution	CH01-08: 4K	CH01-16: 4K	CH01-08: 4K	CH01-08: 4K	CH01-16: 4K	CH01-08: 4K	CH01: 4K CH02-04: 4K-N/4MP
Max. HDCVI Recording Rate	15fps@4K, 20fps@6MP 20fps@5MP, 30fps@4MP 30fps@3MP, 30fps@1080P	7fps@4K, 10fps@6MP 12fps@5MP, 15fps@4MP 15fps@3MP, 30fps@4M-N 30fps@1080P	7fps@4K, 10fps@6MP 12fps@5MP, 15fps@4MP 15fps@3MP, 30fps@4M-N 30fps@1080P	15fps@4K, 20fps@6MP 20fps@5MP, 30fps@4MP 30fps@3MP, 30fps@1080P	7fps@4K, 10fps@6MP 12fps@5MP, 15fps@4MP 15fps@3MP, 30fps@4M-N 30fps@1080P	7fps@4K, 10fps@6MP 12fps@5MP, 15fps@4MP 15fps@3MP, 30fps@4M-N 30fps@1080P	7fps@4K, 10fps@6MP 12fps@5MP, 15fps@4K-N 15fps@4MP, 15fps@3MP 30fps@4M-N, 30fps@1080P
CVBS Input	8CH,1.0Vp-p,75Ω	16CH,1.0Vp-p,75Ω	8CH,1.0Vp-p,75Ω	8CH,1.0Vp-p,75Ω	16CH,1.0Vp-p,75Ω	8CH,1.0Vp-p,75Ω	4CH,1.0Vp-p,75Ω
IP Camera Input	8+8 Up to 8MP	16+16 Up to 8MP	8+8 Up to 8MP	8+8 Up to 8MP	16+16 Up to 8MP	8+8 Up to 8MP	4+4 Up to 8MP
Max IP Input/Record	64Mbps/64Mbps	128Mbps/128Mbps	64Mbps/64Mbps	64Mbps/64Mbps	128Mbps/128Mbps	64Mbps/64Mbps	32Mbps/32Mbps
Audio In/out	4/1, 2-way	4/1, 2-way	4/1, 2-way	8/1, 2-way	16/1, 2-way	8/1, 2-way	4/1, 2-way
Max HDD	2×10TB	2×10TB	2×10TB	1×10TB	1×10TB	1×10TB	1×10TB
Display	HDMI(3840x2160) VGA(1920x1080) SPOT (configurable)	HDMI(3840x2160) VGA(1920x1080) SPOT (configurable)	HDMI(3840x2160) VGA(1920x1080) SPOT (configurable)	HDMI(3840x2160) VGA(1920x1080) SPOT (configurable)	HDMI(3840x2160) VGA(1920x1080) SPOT (configurable)	HDMI(3840x2160) VGA(1920x1080) SPOT (configurable)	HDMI(2560x1440) VGA(1920x1080) SPOT (configurable)
eSATA	-	-	-	-	-	-	-
USB	1 USB3.0, 1 USB2.0	1 USB3.0, 1 USB2.0	1 USB3.0, 1 USB2.0	1 USB3.0, 1 USB2.0	1 USB3.0, 1 USB2.0	1 USB3.0, 1 USB2.0	2 USB2.0
DVD Burner	USB	USB	USB	USB	USB	USB	USB
Alarm In/Out	8/3	16/3	8/3	8/3	16/3	8/3	8/3
Ethernet	1 Gigabit port	1 Gigabit port	1 Gigabit port	1 Gigabit port	1 Gigabit port	1 Gigabit port	1x100M port
Remote User Login	128	128	128	128	128	128	128
Dimensions	375×287×53mm (14.8"×11.3"×2.1")	375×287×53mm (14.8"×11.3"×2.1")	375×287×53mm (14.8"×11.3"×2.1")	325×255×55mm (12.8"×10.0"×2.2")	325×255×55mm (12.8"×10.0"×2.2")	325×255×55mm (12.8"×10.0"×2.2")	325×255×55mm (12.8"×10.0"×2.2")
Power	DC12V/5A, ≤15W (Without HDD)	DC12V/5A, ≤15W (Without HDD)	DC12V/4A, ≤10W (Without HDD)	DC12V/2A, ≤15W(Without HDD)	DC12V/3A, ≤15W(Without HDD)	DC12V/2A, ≤10W(Without HDD)	DC12V/2A, ≤10W(Without HDD)
Intelligent Video	Tripwire,Intrusion, Abandoned/ Missing, Face Detection	Tripwire,Intrusion, Abandoned/ Missing, Face Detection	Tripwire,Intrusion, Abandoned/ Missing, Face Detection	Tripwire,Intrusion,Abandoned/ Missing,Face Detection	Tripwire,Intrusion,Abandoned/ Missing,Face Detection	Tripwire,Intrusion,Abandoned/ Missing,Face Detection	Tripwire,Intrusion,Abandoned/ Missing,Face Detection
Star Features	IoT, POS, P2P, Coaxial Audio/ Alarm/Upgrade, 2D/3DNR	IoT, POS, P2P, Coaxial Audio/ Alarm/Upgrade, 2D/3DNR	IoT, POS, P2P, Coaxial Audio/ Alarm/Upgrade, 2D/3DNR	IoT, POS, P2P, Coaxial Audio/ Alarm/Upgrade, 2D/3DNR	IoT, POS, P2P, Coaxial Audio/ Alarm/Upgrade, 2D/3DNR	IoT, POS, P2P, Coaxial Audio/ Alarm/Upgrade, 2D/3DNR	IoT, POS, P2P, Coaxial Audio/ Alarm/Upgrade, 2D/3DNR

HDCVI RECORDERS

Pro Series

1 HDD

Model	XVR7108E-4KL-B-X	XVR7104E-4KL-B-X	XVR7108E-4KL-X	XVR7104E-4KL-X
Appearance	 	 	 	 
Video Compression	H.265+/H.265/H.264+/H.264	H.265+/H.265/H.264+/H.264	H.265+/H.265/H.264+/H.264	H.265+/H.265/H.264+/H.264
Audio Compression	AAC/G.711/PCM	AAC/G.711/PCM	AAC/G.711/PCM	AAC/G.711/PCM
Video Standard	HDCVI/AHD/CVBS/TVI (Auto-detect)	HDCVI/AHD/CVBS/TVI (Auto-detect)	HDCVI/AHD/CVBS/TVI (Auto-detect)	HDCVI/AHD/CVBS/TVI (Auto-detect)
Max. Recording Resolution	CH01-08: 4K	CH01-04: 4K	CH01-08: 4K	CH01-04: 4K
Max. HDCVI Recording Rate	7fps@4K, 10fps@6MP 12fps@5MP, 15fps@4MP 15fps@3MP, 30fps@4M-N 30fps@1080P	7fps@4K, 10fps@6MP 12fps@5MP, 15fps@4MP 15fps@3MP, 30fps@4M-N 30fps@1080P	7fps@4K, 10fps@6MP 12fps@5MP, 15fps@4MP 15fps@3MP, 30fps@4M-N 30fps@1080P	7fps@4K, 10fps@6MP 12fps@5MP, 15fps@4MP 15fps@3MP, 30fps@4M-N 30fps@1080P
CVBS Input	8CH,1.0Vp-p,75Ω	4CH,1.0Vp-p,75Ω	8CH,1.0Vp-p,75Ω	4CH,1.0Vp-p,75Ω
IP Camera Input	8+8 Up to 8MP	4+4 Up to 8MP	8+8 Up to 8MP	4+4 Up to 8MP
Max IP Input/Record	64Mbps/64Mbps	32Mbps/32Mbps	64Mbps/64Mbps	32Mbps/32Mbps
Audio In/out	1/1, 2-way	1/1, 2-way	1/1, 2-way	1/1, 2-way
Max HDD	1×10TB	1×10TB	1×10TB	1×10TB
Display	HDMI(3840x2160) VGA(1920x1080) SPOT (configurable)	HDMI(3840x2160) VGA(1920x1080) SPOT (configurable)	HDMI(3840x2160) VGA(1920x1080) SPOT (configurable)	HDMI(3840x2160) VGA(1920x1080) SPOT (configurable)
eSATA	-	-	-	-
USB	1 USB3.0, 2 USB2.0	1 USB3.0, 2 USB2.0	1 USB3.0, 2 USB2.0	1 USB3.0, 2 USB2.0
DVD Burner	USB	USB	USB	USB
Alarm In/Out	-	-	-	-
Ethernet	1 Gigabit port	1 Gigabit port	1 Gigabit port	1 Gigabit port
Remote User Login	128	128	128	128
Dimensions	260×140×87mm (10.2"×5.5"×3.4")	260×140×87mm (10.2"×5.5"×3.4")	260×140×87mm (10.2"×5.5"×3.4")	260×140×87mm (10.2"×5.5"×3.4")
Power	DC12V/5A, ≤10W(Without HDD)	DC12V/4A, ≤10W(Without HDD)	DC12V/2A, ≤10W(Without HDD)	DC12V/2A, ≤10W(Without HDD)
Intelligent Video	Tripwire,Intrusion,Abandoned/ Missing,Face Detection	Tripwire,Intrusion,Abandoned/ Missing,Face Detection	Tripwire,Intrusion,Abandoned/ Missing,Face Detection	Tripwire,Intrusion,Abandoned/ Missing,Face Detection
Star Features	Built-in Battery, IoT, POS, P2P Coaxial Audio/Alarm/Upgrade, 2D/3DNR	Built-in Battery, IoT, POS, P2P Coaxial Audio/Alarm/Upgrade, 2D/3DNR	IoT, POS, P2P Coaxial Audio/Alarm/Upgrade, 2D/3DNR	IoT, POS, P2P Coaxial Audio/Alarm/Upgrade, 2D/3DNR

HDCVI RECORDERS

HDCVI RECORDERS

Lite Series

The Lite Series is designed for high cost performance and quality. The range offers a great solution for users facing budget constraints who both require quality and performance.

The adoption of Smart H.265+/H.265 improves encoding efficiency, saving on bandwidth/storage costs, and significantly reducing the Total Cost of Ownership (TCO).

⊕ KEY FEATURES

Cost/Performance

Advanced processors provide good image quality and color with optimized cost effectiveness

H.265+/H.265

Improves encoding efficiency, reducing overall system cost









High Definition

Up to 4K resolution available

All-over-Coax

Coaxial audio/alarm/firmware upgrade

Lite Series

	2 HDD		1 HDD	2 HDD	
Model	XVR5216AN-4KL-X-16P	XVR5208AN-4KL-X-8P	XVR5108H-4KL-X-8P	XVR5216AN-4KL-X	XVR5208AN-4KL-X
Appearance	 	 	 		
Video Compression	H.265+/H.265/H.264+/H.264	H.265+/H.265/H.264+/H.264	H.265+/H.265/H.264+/H.264	H.265+/H.265/H.264+/H.264	H.265+/H.265/H.264+/H.264
Audio Compression	AAC/G.711/PCM	AAC/G.711/PCM	AAC/G.711/PCM	AAC/G.711/PCM	AAC/G.711/PCM
Video Standard	HDCVI/AHD/CVBS/TVI (Auto-detect)	HDCVI/AHD/CVBS/TVI (Auto-detect)	HDCVI/AHD/CVBS/TVI (Auto-detect)	HDCVI/AHD/CVBS/TVI (Auto-detect)	HDCVI/AHD/CVBS/TVI (Auto-detect)
Max. Recording Resolution	CH01-16: 4K	CH01-08: 4K	CH01-08: 4K	CH01-16: 4K	CH01-08: 4K
Max. HDCVI Recording Rate	7fps@4K, 10fps@6MP 12fps@5MP, 15fps@4MP 15fps@3MP, 30fps@4M-N 30fps@1080P	7fps@4K, 10fps@6MP 12fps@5MP, 15fps@4MP 15fps@3MP, 30fps@4M-N 30fps@1080P	7fps@4K, 10fps@6MP 12fps@5MP, 15fps@4MP 15fps@3MP, 30fps@4M-N 30fps@1080P	7fps@4K, 10fps@6MP 12fps@5MP, 15fps@4MP 15fps@3MP, 30fps@4M-N 30fps@1080P	7fps@4K, 10fps@6MP 12fps@5MP, 15fps@4MP 15fps@3MP, 30fps@4M-N 30fps@1080P
CVBS Input	16CH,1.0Vp-p,75Ω	8CH,1.0Vp-p,75Ω	8CH,1.0Vp-p,75Ω	16CH,1.0Vp-p,75Ω	8CH,1.0Vp-p,75Ω
IP Camera Input	16+8 Up to 8Mp	8+4 Up to 8Mp	8+4 Up to 8Mp	16+8 Up to 8MP	8+4 Up to 8MP
Max IP Input/Record	96Mbps/96Mbps	48Mbps/48Mbps	48Mbps/48Mbps	96Mbps/96Mbps	48Mbps/48Mbps
Audio In/out	1/1, 2-way	1/1, 2-way	1/1, 2-way	1/1, 2-way	1/1, 2-way
Max HDD	2×10TB	2×10TB	1×10TB	2×10TB	2×10TB
Display	HDMI(3840x2160) VGA(1920x1080), TV	HDMI(3840x2160) VGA(1920x1080)	HDMI(3840x2160) VGA(1920x1080)	HDMI(3840x2160) VGA(1920x1080)	HDMI(3840x2160) VGA(1920x1080)
eSATA	-	-	-	-	-
USB	1 USB3.0, 1 USB2.0	1 USB3.0, 1 USB2.0	1 USB3.0, 1 USB2.0	1 USB3.0, 1 USB2.0	1 USB3.0, 1 USB2.0
DVD Burner	USB	USB	USB	USB	USB
Alarm In/Out	-	-	-	-	-
Ethernet	1 Gigabit port	1 Gigabit port	1 Gigabit port	1 Gigabit port	1 Gigabit port
Remote User Login	128	128	128	128	128
Dimensions	375×287×53mm (14.8"×11.3"×2.1")	375×287×53mm (14.8"×11.3"×2.1")	325×255×55mm (12.8"×10.0"×2.2")	375×287×53mm (14.8"×11.3"×2.1")	375×287×53mm (14.8"×11.3"×2.1")
Power	DC54V, ≤20W(Without HDD)	DC53V, ≤10W(Without HDD)	DC53V, ≤10W(Without HDD)	DC12V/5A, ≤15W(Without HDD)	DC12V/4A, ≤15W(Without HDD)
Intelligent Video	Tripwire,Intrusion,Abandoned/ Missing,Face Detection	Tripwire,Intrusion,Abandoned/ Missing,Face Detection	Tripwire,Intrusion,Abandoned/ Missing,Face Detection	Tripwire,Intrusion,Abandoned/ Missing,Face Detection	Tripwire,Intrusion,Abandoned/ Missing,Face Detection
Star Features	PoC,POS,P2P,Coaxial Audio/ Alarm/Upgrade,2D/3DNR	PoC,POS,P2P,Coaxial Audio/ Alarm/Upgrade,2D/3DNR	PoC,POS,P2P,Coaxial Audio/ Alarm/Upgrade,2D/3DNR	POS,P2P, Coaxial Audio/ Alarm/Upgrade, 2D/3DNR	POS, P2P, Coaxial Audio/ Alarm/Upgrade, 2D/3DNR

HDCVI RECORDERS

Lite Series

1 HDD

Model	XVR5116H-4KL-X	XVR5108H-4KL-X	XVR5104H-4KL-X	XVR5108HS-4KL-X	XVR5104HS-4KL-X	XVR5104C-4KL-X
Appearance						
Video Compression	H.265+/H.265/H.264+/H.264	H.265+/H.265/H.264+/H.264	H.265+/H.265/H.264+/H.264	H.265+/H.265/H.264+/H.264	H.265+/H.265/H.264+/H.264	H.265+/H.265/H.264+/H.264
Audio Compression	AAC/G.711/PCM	AAC/G.711/PCM	AAC/G.711/PCM	AAC/G.711/PCM	AAC/G.711/PCM	AAC/G.711/PCM
Video Standard	HDCVI/AHD/CVBS/TVI (Auto-detect)	HDCVI/AHD/CVBS/TVI (Auto-detect)	HDCVI/AHD/CVBS/TVI (Auto-detect)	HDCVI/AHD/CVBS/TVI (Auto-detect)	HDCVI/AHD/CVBS/TVI (Auto-detect)	HDCVI/AHD/CVBS/TVI (Auto-detect)
Max. Recording Resolution	CH01-16: 4K	CH01-08: 4K	CH01: 4K CH02-04: 4K-N/4MP	CH01-08: 4K	CH01: 4K CH02-04: 4K-N/4MP	CH01: 4K CH02-04: 4K-N/4MP
Max. HDCVI Recording Rate	7fps@4K, 10fps@6MP 12fps@5MP, 15fps@4MP 15fps@3MP, 30fps@4M-N 30fps@1080P	7fps@4K, 10fps @6MP 12fps@5MP, 15fps@4MP 15fps@3MP, 30fps@4M-N 30fps@1080P	7fps@4K, 10fps@6MP 12fps@5MP, 15fps@4K-N 15fps@4MP, 15fps@3MP 30fps@4M-N, 30fps@1080P	7fps@4K, 10fps@6MP 12fps@5MP, 15fps@4MP 15fps@3MP, 30fps@4M-N 30fps@1080P	7fps@4K, 10fps@6MP 12fps@5MP, 15fps@4K-N 15fps@4MP, 15fps@3MP 30fps@4M-N, 30fps@1080P	7fps@4K, 10fps@6MP 12fps@5MP, 15fps@4K-N 15fps@4MP, 15fps@3MP 30fps@4M-N, 30fps@1080P
CVBS Input	16CH,1.0Vp-p,75Ω	8CH,1.0Vp-p,75Ω	4CH,1.0Vp-p,75Ω	8CH,1.0Vp-p,75Ω	4CH,1.0Vp-p,75Ω	4CH,1.0Vp-p,75Ω
IP Camera Input	16+8 Up to 8MP	8+4 Up to 8MP	4+2 Up to 8MP	8+4 Up to 8MP	4+2 Up to 8MP	4+2 Up to 8MP
Max IP Input/Record	96Mbps/96Mbps	48Mbps/48Mbps	24Mbps/24Mbps	48Mbps/48Mbps	24Mbps/24Mbps	24Mbps/24Mbps
Audio In/out	1/1, 2-way	1/1, 2-way	1/1, 2-way	1/1, 2-way	1/1, 2-way	1/1, 2-way
Max HDD	1x10TB	1x10TB	1x10TB	1x10TB	1x10TB	1x10TB
Display	HDMI(3840x2160) VGA(1920x1080)	HDMI(3840x2160) VGA(1920x1080)	HDMI(2560x1440) VGA(1920x1080)	HDMI(3840x2160) VGA(1920x1080)	HDMI(2560x1440) VGA(1920x1080)	HDMI(2560x1440) VGA(1920x1080)
eSATA	-	-	-	-	-	-
USB	1 USB3.0, 1 USB2.0	1 USB3.0, 1 USB2.0	2 USB2.0	1 USB3.0, 1 USB2.0	2 USB2.0	2 USB2.0
DVD Burner	USB	USB	USB	USB	USB	USB
Alarm In/Out	-	-	-	-	-	-
Ethernet	1 Gigabit port	1 Gigabit port	1x100M port	1 Gigabit port	1x100M port	1x100M port
Remote User Login	128	128	128	128	128	128
Dimensions	325x255x55mm (12.8"x10.0"x2.2")	325x255x55mm (12.8"x10.0"x2.2")	325x255x55mm (12.8"x10.0"x2.2")	260x236x48mm (10.2"x9.3"x1.9")	260x236x48mm (10.2"x9.3"x1.9")	205x211x45mm (8.1"x8.3"x1.8")
Power	DC12V/3A, ≤15W(Without HDD)	DC12V/2A, ≤10W(Without HDD)	DC12V/2A, ≤10W(Without HDD)	DC12V/2A, ≤10W(Without HDD)	DC12V/2A, ≤10W(Without HDD)	DC12V/2A, ≤10W(Without HDD)
Intelligent Video	Tripwire,Intrusion,Abandoned/ Missing,Face Detection	Tripwire,Intrusion,Abandoned/ Missing,Face Detection	Tripwire,Intrusion,Abandoned/ Missing,Face Detection	Tripwire,Intrusion,Abandoned/ Missing, Face Detection	Tripwire,Intrusion,Abandoned/ Missing, Face Detection	Tripwire,Intrusion,Abandoned/ Missing, Face Detection
Star Features	POS, P2P, Coaxial Audio/Alarm/ Upgrade, 2D/3DNR	POS, P2P, Coaxial Audio/Alarm/ Upgrade, 2D/3DNR	POS, P2P, Coaxial Audio/Alarm/ Upgrade, 2D/3DNR	POS, P2P,Coaxial Audio/Alarm/ Upgrade, 2D/3DNR	POS, P2P,Coaxial Audio/Alarm/ Upgrade, 2D/3DNR	POS, P2P,Coaxial Audio/Alarm/ Upgrade, 2D/3DNR

HDCVI RECORDERS

HDCVI RECORDERS

Lite Series

	8 HDD	4 HDD		2 HDD	
Model	XVR5832S-X	XVR5432L-X	XVR5232AN-X	XVR5216AN-X	XVR5216A-X
Appearance					
Video Compression	H.265+/H.265/H.264+/H.264	H.265+/H.265/H.264+/H.264	H.265+/H.265/H.264+/H.264	H.265+/H.265/H.264+/H.264	H.265+/H.265/H.264+/H.264
Audio Compression	AAC/G.711/PCM	AAC/G.711/PCM	AAC/G.711/PCM	AAC/G.711/PCM	AAC/G.711/PCM
Video Standard	HDCVI/AHD/CVBS/TVI (Auto-detect)	HDCVI/AHD/CVBS/TVI (Auto-detect)	HDCVI/AHD/CVBS/TVI (Auto-detect)	HDCVI/AHD/CVBS/TVI (Auto-detect)	HDCVI/AHD/CVBS/TVI (Auto-detect)
Max. Recording Resolution	CH01-32: 4M-N/1080P	CH01-32: 4M-N/1080P	CH01-32: 4M-N/1080P	CH01-16: 4M-N/1080P	CH01-16: 4M-N/1080P
Max. HDCVI Recording Rate	15fps@4M-N 15fps@1080P 30fps@720P	15fps@4M-N 15fps@1080P 30fps@720P	15fps@4M-N 15fps@1080P 30fps@720P	15fps@4M-N 15fps@1080P 30fps@720P	15fps@4M-N 15fps@1080P 30fps@720P
CVBS Input	32CH,1.0Vp-p,75Ω	32CH,1.0Vp-p,75Ω	32CH,1.0Vp-p,75Ω	16CH,1.0Vp-p,75Ω	16CH,1.0Vp-p,75Ω
IP Camera Input	32 Up to 6MP	32 Up to 6MP	32 Up to 6MP	16+8 Up to 6MP	16+8 Up to 6MP
Max IP Input/Record	128Mbps/128Mbps	128Mbps/128Mbps	128Mbps/128Mbps	96Mbps/96Mbps	96Mbps/96Mbps
Audio In/out	16/1, 2-way	4/1, 2-way	1/1, 2-way	1/1, 2-way	4/1, 2-way
Max HDD	8x10TB	4x10TB	2x10TB	2x10TB	2x10TB
Display	2HDMI/VGA(1920x1080),TV	2HDMI/VGA(1920x1080),TV	HDMI/VGA(1920x1080) TV	HDMI/VGA(1920x1080)	HDMI/VGA(1920x1080)
eSATA	1	1	-	-	-
USB	2 USB 3.0, 2 USB 2.0	2 USB 3.0, 1 USB 2.0	1 USB3.0, 1 USB2.0	1 USB3.0, 1 USB2.0	1 USB3.0, 1 USB2.0
DVD Burner	USB/SATA	USB/SATA	USB	USB	USB
Alarm In/Out	16/6	16/6	-	-	16/3
Ethernet	2 Gigabit ports	1 Gigabit port	1 Gigabit port	1 Gigabit port	1 Gigabit port
Remote User Login	128	128	128	128	128
Dimensions	440x455x95mm (17.3"x17.9"x3.7")	440x417x76mm (17.3"x16.4"x3.0")	375x287x53mm (14.8"x11.3"x2.1")	375x287x53mm (14.8"x11.3"x2.1")	375x287x53mm (14.8"x11.3"x2.1")
Power	AC 100-240V,50/60Hz, ≤35W(Without HDD)	AC 100-240V,50/60Hz, ≤35W(Without HDD)	DC12V/5A, ≤15W(Without HDD)	DC12V/4A, ≤15W(Without HDD)	DC12V/4A, ≤15W(Without HDD)
Intelligent Video	Tripwire,Intrusion,Abandoned/ Missing, Face Detection	Tripwire,Intrusion,Abandoned/ Missing, Face Detection	Tripwire,Intrusion,Abandoned/ Missing,Face Detection	Tripwire,Intrusion,Abandoned/ Missing,Face Detection	Tripwire,Intrusion,Abandoned/ Missing,Face Detection
Star Features	POS, P2P,Coaxial Audio/Alarm/ Upgrade, 2D/3DNR	POS, P2P,Coaxial Audio/Alarm/ Upgrade, 2D/3DNR	POS, P2P, Coaxial Audio/Alarm/ Upgrade, 2D/3DNR	POS, P2P, Coaxial Audio/Alarm/ Upgrade, 2D/3DNR	POS, P2P, Coaxial Audio/Alarm/ Upgrade, 2D/3DNR

HDCVI RECORDERS

Lite Series

1 HDD

Model	XVR5116HE-X	XVR5108HE-X	XVR5104HE-X	XVR5116H-X	XVR5108H-X	XVR5104H-X
Appearance						
Video Compression	H.265+/H.265/H.264+/H.264	H.265+/H.265/H.264+/H.264	H.265+/H.265/H.264+/H.264	H.265+/H.265/H.264+/H.264	H.265+/H.265/H.264+/H.264	H.265+/H.265/H.264+/H.264
Audio Compression	AAC/G.711/PCM	AAC/G.711/PCM	AAC/G.711/PCM	AAC/G.711/PCM	AAC/G.711/PCM	AAC/G.711/PCM
Video Standard	HDCVI/AHD/CVBS/TVI (Auto-detect)	HDCVI/AHD/CVBS/TVI (Auto-detect)	HDCVI/AHD/CVBS/TVI (Auto-detect)	HDCVI/AHD/CVBS/TVI (Auto-detect)	HDCVI/AHD/CVBS/TVI (Auto-detect)	HDCVI/AHD/CVBS/TVI (Auto-detect)
Max. Recording Resolution	CH01-16: 4M-N/1080P	CH01-08: 4M-N/1080P	CH01-04: 4M-N/1080P	CH01-16: 4M-N/1080P	CH01-08: 4M-N/1080P	CH01-04: 4M-N/1080P
Max. HDCVI Recording Rate	15fps@4M-N 15fps@1080P 30fps@720P	15fps@4M-N 15fps@1080P 30fps@720P	15fps@4M-N 15fps@1080P 30fps@720P	15fps@4M-N 15fps@1080P 30fps@720P	15fps@4M-N 15fps@1080P 30fps@720P	15fps@4M-N 15fps@1080P 30fps@720P
CVBS Input	16CH,1.0Vp-p,75Ω	8CH,1.0Vp-p,75Ω	4CH,1.0Vp-p,75Ω	16CH,1.0Vp-p,75Ω	8CH,1.0Vp-p,75Ω	4CH,1.0Vp-p,75Ω
IP Camera Input	16+8 Up to 6MP	8+4 Up to 6MP	4+2 Up to 6MP	16+8 Up to 6MP	8+4 Up to 6MP	4+2 Up to 6MP
Max IP Input/Record	96Mbps/96Mbps	48Mbps/48Mbps	24Mbps/24Mbps	96Mbps/96Mbps	48Mbps/48Mbps	24Mbps/24Mbps
Audio In/out	16/1, 2-way	8/1, 2-way	4/1, 2-way	1/1, 2-way	1/1, 2-way	1/1, 2-way
Max HDD	1x10TB	1x10TB	1x10TB	1x10TB	1x10TB	1x10TB
Display	HDMI/VGA(1920x1080)	HDMI/VGA(1920x1080)	HDMI/VGA(1920x1080)	HDMI/VGA(1920x1080)	HDMI/VGA(1920x1080)	HDMI/VGA(1920x1080)
eSATA	-	-	-	-	-	-
USB	1 USB3.0, 1 USB2.0	2 USB2.0	2 USB2.0	1 USB3.0, 1 USB2.0	2 USB2.0	2 USB2.0
DVD Burner	USB	USB	USB	USB	USB	USB
Alarm In/Out	16/3	8/3	8/3	-	-	-
Ethernet	1 Gigabit port	1x100M port	1x100M port	1 Gigabit port	1x100M port	1x100M port
Remote User Login	128	128	128	128	128	128
Dimensions	325x255x55mm (12.8"x10.0"x2.2")	325x255x55mm (12.8"x10.0"x2.2")	325mmx255mmx55mm (12.8"x10.0"x2.2")	325x255x55mm (12.8"x10.0"x2.2")	325x255x55mm (12.8"x10.0"x2.2")	325mmx255mmx55mm (12.8"x10.0"x2.2")
Power	DC12V/2A, ≤10W(Without HDD)	DC12V/2A, ≤10W(Without HDD)	DC12V/2A, ≤10W(Without HDD)	DC12V/2A, ≤10W(Without HDD)	DC12V/2A, ≤10W(Without HDD)	DC12V/2A, ≤10W(Without HDD)
Intelligent Video	Tripwire,Intrusion,Abandoned/ Missing,Face Detection	Tripwire,Intrusion,Abandoned/ Missing,Face Detection	Tripwire,Intrusion,Abandoned/ Missing,Face Detection	Tripwire,Intrusion,Abandoned/ Missing,Face Detection	Tripwire,Intrusion,Abandoned/ Missing,Face Detection	Tripwire,Intrusion,Abandoned/ Missing,Face Detection
Star Features	POS, P2P, Coaxial Audio/Alarm/ Upgrade, 2D/3DNR	POS, P2P, Coaxial Audio/Alarm/ Upgrade, 2D/3DNR	POS,P2P,Coaxial Audio/Alarm/ Upgrade, 2D/3DNR	POS, P2P, Coaxial Audio/Alarm/ Upgrade, 2D/3DNR	POS, P2P,Coaxial Audio/Alarm/ Upgrade, 2D/3DNR	POS,P2P,Coaxial Audio/Alarm/ Upgrade, 2D/3DNR

HDCVI RECORDERS

HDCVI RECORDERS

Lite Series

1 HDD

Model	XVR5116HS-X	XVR5108HS-X	XVR5104HS-X	XVR5108C-X	XVR5104C-X
Appearance					
Video Compression	H.265+/H.265/H.264+/H.264	H.265+/H.265/H.264+/H.264	H.265+/H.265/H.264+/H.264	H.265+/H.265/H.264+/H.264	H.265+/H.265/H.264+/H.264
Audio Compression	AAC/G.711/PCM	AAC/G.711/PCM	AAC/G.711/PCM	AAC/G.711/PCM	AAC/G.711/PCM
Video Standard	HDCVI/AHD/CVBS/TVI (Auto-detect)	HDCVI/AHD/CVBS/TVI (Auto-detect)	HDCVI/AHD/CVBS/TVI (Auto-detect)	HDCVI/AHD/CVBS/TVI (Auto-detect)	HDCVI/AHD/CVBS/TVI (Auto-detect)
Max. Recording Resolution	CH01-16: 4M-N/1080P	CH01-08: 4M-N/1080P	CH01-04: 4M-N/1080P	CH01-08: 4M-N/1080P	CH01-04: 4M-N/1080P
Max. HDCVI Recording Rate	15fps@4M-N 15fps@1080P 30fps@720P	15fps@4M-N 15fps@1080P 30fps@720P	15fps@4M-N 15fps@1080P 30fps@720P	15fps@4M-N 15fps@1080P 30fps@720P	15fps@4M-N 15fps@1080P 30fps@720P
CVBS Input	16CH,1.0Vp-p,75Ω	8CH,1.0Vp-p,75Ω	4CH,1.0Vp-p,75Ω	8CH,1.0Vp-p,75Ω	4CH,1.0Vp-p,75Ω
IP Camera Input	16+8 Up to 6MP	8+4 Up to 6MP	4+2 Up to 6MP	8+4 Up to 6MP	4+2 Up to 6MP
Max IP Input/Record	96Mbps/96Mbps	48Mbps/48Mbps	24Mbps/24Mbps	48Mbps/48Mbps	24Mbps/24Mbps
Audio In/out	1/1, 2-way	1/1, 2-way	1/1, 2-way	1/1, 2-way	1/1, 2-way
Max HDD	1×10TB	1×10TB	1×10TB	1×10TB	1×10TB
Display	HDMI/VGA(1920x1080)	HDMI/VGA(1920x1080)	HDMI/VGA(1920x1080)	HDMI/VGA(1920x1080)	HDMI/VGA(1920x1080)
eSATA	-	-	-	-	-
USB	1 USB3.0, 1 USB2.0	2 USB2.0	2 USB2.0	2 USB2.0	2 USB2.0
DVD Burner	USB	USB	USB	USB	USB
Alarm In/Out	-	-	-	-	-
Ethernet	1 Gigabit port	1x100M port	1x100M port	1x100M port	1x100M port
Remote User Login	128	128	128	128	128
Dimensions	260×236×48mm (10.2"×9.3"×1.9")	260×236×48mm (10.2"×9.3"×1.9")	260×236×48mm (10.2"×9.3"×1.9")	205×211×45mm (8.1"×8.3"×1.8")	205×211×45mm (8.1"×8.3"×1.8")
Power	DC12V/2A, ≤10W(Without HDD)	DC12V/2A, ≤10W(Without HDD)	DC12V/2A, ≤10W(Without HDD)	DC12V/2A, ≤10W(Without HDD)	DC12V/2A, ≤10W(Without HDD)
Intelligent Video	Tripwire,Intrusion,Abandoned/ Missing,Face Detection	Tripwire,Intrusion,Abandoned/ Missing,Face Detection	Tripwire,Intrusion,Abandoned/ Missing,Face Detection	Tripwire,Intrusion,Abandoned/ Missing,Face Detection	Tripwire,Intrusion,Abandoned/ Missing,Face Detection
Star Features	POS, P2P,Coaxial Audio/Alarm/ Upgrade, 2D/3DNR	POS, P2P, Coaxial Audio/Alarm/ Upgrade, 2D/3DNR	POS,P2P, Coaxial Audio/Alarm/Upgrade, 2D/3DNR	POS, P2P, Coaxial Audio/Alarm/ Upgrade, 2D/3DNR	POS, P2P, Coaxial Audio/Alarm/ Upgrade, 2D/3DNR

HDCVI RECORDERS

Lite Series

	2 HDD		1 HDD				
Model	XVR4232AN-X	XVR4216AN-X	XVR4116HS-X	XVR4108HS-X	XVR4104HS-X	XVR4108C-X	XVR4104C-X
Appearance							
Video Compression	H.265/H.264	H.265/H.264	H.265/H.264	H.265/H.264	H.265/H.264	H.265/H.264	H.265/H.264
Audio Compression	AAC/G.711/PCM	AAC/G.711/PCM	AAC/G.711/PCM	AAC/G.711/PCM	AAC/G.711/PCM	AAC/G.711/PCM	AAC/G.711/PCM
Video Standard	HDCVI/AHD/CVBS/TVI (Auto-detect)	HDCVI/AHD/CVBS/TVI (Auto-detect)	HDCVI/AHD/CVBS/TVI (Auto-detect)	HDCVI/AHD/CVBS/TVI (Auto-detect)	HDCVI/AHD/CVBS/TVI (Auto-detect)	HDCVI/AHD/CVBS/TVI (Auto-detect)	HDCVI/AHD/CVBS/TVI (Auto-detect)
Max. Recording Resolution	CH01-32: 1080N/720P	CH01-16: 1080N/720P	CH01-16: 1080N/720P	CH01-08: 1080N/720P	CH01-04: 1080N/720P	CH01-08: 1080N/720P	CH01-04: 1080N/720P
Max. HDCVI Recording Rate	15fps@1080N 15fps@720P	15fps@1080N 15fps@720P	15fps@1080N 15fps@720P	15fps@1080N 15fps@720P	30fps@1080N 30fps@720P	15fps@1080N 15fps@720P	30fps@1080N 30fps@720P
CVBS Input	32CH,1.0Vp-p,75Ω	16CH,1.0Vp-p,75Ω	16CH,1.0Vp-p,75Ω	8CH,1.0Vp-p,75Ω	4CH,1.0Vp-p,75Ω	8CH,1.0Vp-p,75Ω	4CH,1.0Vp-p,75Ω
IP Camera Input	16 Up to 6MP	16+2 Up to 6MP	16+2 Up to 6MP	8+2 Up to 6Mp	4+1 Up to 2Mp	8+2 Up to 6Mp	4+1 Up to 2Mp
Max IP Input/Record	64Mbps/64Mbps	72Mbps/72Mbps	72Mbps/72Mbps	40Mbps/40Mbps	20Mbps/20Mbps	40Mbps/40Mbps	20Mbps/20Mbps
Audio In/out	1/1, 2-way	1/1, 2-way	1/1, 2-way	1/1, 2-way	1/1, 2-way	1/1, 2-way	1/1, 2-way
Max HDD	2×10TB	2×10TB	1×10TB	1×10TB	1×10TB	1×10TB	1×10TB
Display	HDMI/VGA(1920x1080) TV	HDMI/VGA(1920x1080)	HDMI/VGA(1920x1080)	HDMI/VGA(1920x1080)	HDMI/VGA(1920x1080)	HDMI/VGA(1920x1080)	HDMI/VGA(1920x1080)
eSATA	-	-	-	-	-	-	-
USB	1 USB3.0, 1 USB2.0	2 USB2.0	2 USB2.0	2 USB2.0	2 USB2.0	2 USB2.0	2 USB2.0
DVD Burner	USB	USB	USB	USB	USB	USB	USB
Alarm In/Out	-	-	-	-	-	-	-
Ethernet	1 Gigabit port	1x100M port	1x100M port	1x100M port	1x100M port	1x100M port	1x100M port
Remote User Login	128	128	128	128	128	128	128
Dimensions	375×287×53mm (14.8"×11.3"×2.1")	375×287×53mm (14.8"×11.3"×2.1")	260×236×48mm (10.2"×9.3"×1.9")	260×236×48mm (10.2"×9.3"×1.9")	260×236×48mm (10.2"×9.3"×1.9")	205×211×45mm (8.1"×8.3"×1.8")	205×211×45mm (8.1"×8.3"×1.8")
Power	DC12V/4A, ≤15W(Without HDD)	DC12V/4A, ≤15W(Without HDD)	DC12V/2A, ≤10W (Without HDD)	DC12V/2A, ≤10W (Without HDD)	DC12V/2A, ≤10W (Without HDD)	DC12V/2A, ≤10W (Without HDD)	DC12V/2A, ≤10W (Without HDD)
Intelligent Video	-	-	-	-	-	-	-
Star Features	P2P, Coaxial Audio/Alarm/ Upgrade, 2D/3DNR	P2P, Coaxial Audio/Alarm/ Upgrade, 2D/3DNR	P2P, Coaxial Audio/Alarm/ Upgrade, 2D/3DNR	P2P,Coaxial Audio/Alarm/ Upgrade,2D/3DNR	P2P,Coaxial Audio/Alarm/ Upgrade,2D/3DNR	P2P,Coaxial Audio/Alarm/ Upgrade,2D/3DNR	P2P,Coaxial Audio/Alarm/ Upgrade,2D/3DNR

NETWORK VIDEO SERVERS

Network Video Servers

Network Video Servers (NVS) are specially designed products that convert a traditional analog video signal into a digital video signal. NVS products support various input video formats, including HDCVI, AHD, TVI, CVBS, and IP.

⊕ KEY FEATURES



Variable Inputs Supports HDCVI/AHD/TVI/IP video inputs	Audio Support Supports high quality 2-way audio
Wireless Built-in 2.4G/5G Wi-Fi module and 4G module (optional)	Micro SD Supports max. 128GB SD card

NVS				Alarm Box	
Model	NVS0104HDC	NVS0204HDC	NVS0404HDC	Model	ARB1606
Appearance				Appearance	
Video Compression	H.264+/H.264	H.264+/H.264	H.264+/H.264	Alarm In/Out	16/6
Audio Compression	G.711/PCM	G.711/PCM	G.711/PCM	Communication	1 RS485 port
Video Standard	HDCVI/AHD/CVBS/TVI (Auto-detect)	HDCVI/AHD/CVBS/TVI (Auto-detect)	HDCVI/AHD/CVBS/TVI (Auto-detect)	DIP Switch	2-bit
Max. Record Rate	30fps@1080P 30fps@ 720P	60fps@1080P 60fps@ 720P	60fps@1080P 120fps@1080N/720P	Installation	Desktop installation
CVBS Input	1CH,1.0Vp-p,75Ω	2CH,1.0Vp-p,75Ω	4CH,1.0Vp-p,75Ω	Dimensions	98×90×33mm (3.8"×3.5"×1.3")
IP Camera Input	1CH up to 5MP	2CH up to 5MP	4CH up to 5MP	Net Weight	≤0.2kg
Max IP Input/Record	4Mbps/4Mbps	8Mbps/8Mbps	16Mbps/16Mbps	Power	12V/1A (or use 1 to 2 power cable to use the DVR power) ≤0.2W
Audio out	1/1, 2-way	2/1, 2-way	4/1, 2-way	Star Features	Plug & Play Fanless Design
Max Micro SD	128GB	128GB	128GB		
Display	1 TV	1 TV	1 TV		
Alarm In/Out	4/2	4/2	4/2		
Ethernet	1x100M port	1x100M port	1x100M port		
RS485	1	1	1		
RS232	1	1	1		
Network Module(Optional)	4G/ Wi-Fi(2.4G/5G)	4G/ Wi-Fi(2.4G/5G)	4G/ Wi-Fi(2.4G/5G)		
Remote User Login	128	128	128		
Dimensions	136×162×30mm (5.4"×6.4"×1.2")	136×162×30mm (5.4"×6.4"×1.2")	136×162×30mm (5.4"×6.4"×1.2")		
Power	DC12V/2A, ≤10W (Without HDD)	DC12V/2A, ≤10W (Without HDD)	DC12V/2A, ≤10W (Without HDD)		
Intelligent Video(Optional)	Tripwire,Intrusion, Abandoned/Missing	Tripwire,Intrusion, Abandoned/Missing	Tripwire,Intrusion, Abandoned/Missing		

ACCESSORIES

HFxxE, HFxxG Series		
		
Model	PFB110W	PFB121W
Mount	Wall/ceiling/plane mount	Wall mount



HFWxxE, HFWxxE-Z Series		
		
Model	PFA121	PFA121+PFA152-E
Mount	Junction box	Pole mount

HFWxxR-VF/Z, HFWxxB, HFWxxD, HFWxxT(-Z)-A Series		
		
Model	PFA130-E	PFA130-E+PFA152-E
Mount	Junction box	Pole mount

HFWxxS(L), HFWxxR(M), HFWxxT, MExxB Series		
		
Model	PFA134	PFA134+PFA152-E
Mount	Junction box	Pole mount

PFW3601-A180			
			
Model	PFA124-B	PFA124-B+PFA150	PFA124-B+PFA151
Mount	Junction box	Pole mount	Corner mount

ACCESSORIES

HDBWxxE-Z						
						
Model	PFA138	PFB210W	PFB210W+PFA152-E	PFA101+PFB300C	PFB201C	
Mount	Junction box	Wall mount	Pole mount	Ceiling mount	In-ceiling mount	

HDBWxxR-Z/VF series						
						
Model	PFA137	PFB203W	PFB203W+PFA152-E	PFA106+PFB220C	PFB200C	PFA200W
Mount	Junction box	Wall mount	Pole mount	Ceiling mount(extensible)	In-ceiling mount	Rain shade

HDBWxxE Series				
				
Model	PFA136	PFB203W	PFB203W+PFA152-E	PFA200W
Mount	Junction box	Wall mount	Pole mount	Rain shade



HDWxxR-Z, HDWxxS, HDWxxT-Z-A Series			
			
Model	PFA130-E	PFB203W	PFB203W+PFA152-E
Mount	Junction box	Wall mount	Pole mount

ACCESSORIES

EB Series			
			
Model	PFA136	PFB203W	PFB203W+PFA152-E
Mount	Junction box	Wall mount	Pole mount

HDWxxR-VF Series			
			
Model	PFA13C	PFB204W	PFB204W+PFA152-E
Mount	Junction box	Wall mount	Pole mount

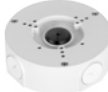
HDWxxM Series			
			
Model	PFA13A-E	PFB204W	PFB204W+PFA152-E
Mount	Junction box	Wall mount	Pole mount









HDWxxR Series		
		
Model	PFA130-E	PFA130-E+PFA152-E
Mount	Junction box	Pole mount

HDWxxEM, HDWxxT-A Series			
			
Model	PFA130-E	PFB204W	PFB204W+PFA152-E
Mount	Junction box	Wall mount	Pole mount

HDBWxxF Series			
			
Model	PFA139	PFB204W	PFB204W+PFA152-E
Mount	Junction box	Wall mount	Pole mount

ACCESSORIES

SD65F/60/6AE Series											
											
Model	PFA111+PFB303W	PFB310W	PFA111+PFB303W+PFA120	PFA111+PFB300C	PFA150	PFA151	PFA140	PFA111+PFB303S			
Mount	Wall mount		Junction box	Ceiling mount	Pole mount	Corner mount	Power box	Parapet mount			

SD49 Series											
											
Model	PFB305W	PFB310W	PFB305W+PFA120	PFA111+PFB300C	PFA150	PFA151	PFA140	PFA111+PFB303S			
Mount	Wall mount		Junction box	Ceiling mount	Pole mount	Corner Mount	Power box	Parapet mount			

SD6C Series											
											
Model	64FB	PFA114+PFB303W+PFA120	PFA114+PFB300C	PFA150	PFA151	PFA140	PFA114+PFB303S				
Mount	Wall mount	Junction box	Ceiling mount	Pole mount	Corner mount	Power box	Parapet mount				





ACCESSORIES

SD59/50/40 Series							
							
Model	PFA110+PFB300S	PFA110+PFB300S+PFA120	PFA110+PFB300C	PFA150	PFA151	PFA140	PFA110+PFB303S
Mount	Wall mount	Junction box	Ceiling mount	Pole mount	Corner mount	Power box	Parapet mount







SD42 Series				
				
Model	PFA102+PFB302S	PFA102+PFB302S+PFA150	PFA102+PFB302S+PFA151	PFA102+PFB300C
Mount	Wall mount	Pole mount	Corner mount	Ceiling mount

SD22 Series				
				
Model	PFA137	PFB203W	PFB203W+PFA152-E	PFB200C
Mount	Junction box	Wall mount	Pole mount	In-ceiling mount









ACCESSORIES









Housings				
Model	PFH610V Series	PFH610A Series	PFH610E Series	PFH610N-IR-W
Appearance				
Description	Aluminum & PC N/A/Heater, cooler/Heater, cooler, IR IP67, IK10 DC12V/AC24V in 404x164x132mm(15.9"x6.45"x5.2")	Aluminum & PC N/A/Heater&cooler/Heater&cooler&IR IP67, IK10, NEMA 4X DC12V/AC24V in 404x164x132mm(15.9"x6.45"x5.2")	Aluminum & PC Heater, cooler/Heater, cooler, IR IP67, IK10, NEMA 4X AC110/220 in 404x164x132mm(15.9"x6.45"x5.2") -65°C ~+55°C	Aluminum & PC Heater, cooler, wiper, IR IP66 AC24V, 5A in 404x164x175mm(15.9"x6.45"x6.89")

Power Adapters			Lenses				
Model	AC Power			PLZ1040-D	PFL0550-E6D	PFL085-J12M	PFL2070-J12M
Appearance							
Description	AC24V, 1.5A 106×70×56.5mm (4.17"×2.76"×2.22")	AC24V, 3A 120×80×63.5mm (4.72"×3.15"×2.15")	AC24V, 5A 120×102×80mm (4.72"×4.0"×3.15")	Image size: 1/2.7" Aperture: F1.6 Focus length: 2.7-12mm Mount: CS Resolution: 4MP	Image size: 1/2.7" Aperture: F1.6 Focus length: 5-50mm Mount: CS Resolution: 6MP	Image size: 4/3" Aperture: F2.8 Focus length: 8.5mm Mount: M43 Resolution: 12MP	Image size: 4/3" Aperture: F1.5 Focus length: 20-70mm Mount: M43 Resolution: 12MP

Testers				Pickups			
Model	PFM900-E	PFM905-E	PFM906	HAP100	HAP200	HAP120	HAP320-V
Appearance							
Description	For IPC, HDCVI, TVI, AHD, analog camera; TDR, analog video generator; Digital multimeter, data monitor, PoE+, DC12V/2A output	For HDCVI, TVI, AHD, analog camera; Analog video generator; Digital multimeter, data monitor, DC12V/1A output	For Wifi, IPC, HDCVI, TVI, AHD, analog, SDI camera; TDR, cable search, cable test, analog video generator, VFL; Digital multimeter, OPM, data monitor, PoE+, DC12V/2A, USB5V/2A output	Input DC12V Scope: 5-40m ² Sensitivity: -40dB 63×30×22mm (2.48"×1.18"×0.87")	Input DC12V Scope: 10-100 m ² Sensitivity: -30dB 79.6×79.6×21.5mm (3.13"×3.13"×0.85")	Scope: 10~70m ² Sensitivity:-34±3dB Working voltage: DC 12V Dimension: Φ40mm×20mm (Φ1.57"×0.79")	Input DC12V Scope: 5-100m ² Sensitivity:-24dB Φ80mm×23.5mm (Φ3.15"×0.93")







ACCESSORIES





Power Adapters							UPS		
Model	DC Power						PFM350-360	PFM350-900	PFM351-900
Appearance									
Description	AC90~264V input DC12V, 1A output -30°C~+70°C CE/FCC/UL/PSE/CCC	AC90~264V input DC12V, 2A output -30°C~+70°C CE/FCC/UL/CCC	AC90~264V input DC12V, 0.7Ax4 output -30°C~+70°C CE/FCC/UL/RCM/CCC	AC90~264V input DC12V, 2A output -10°C~+55°C CE/FCC/UL/RCM/CCC	AC90~264V input DC12V, 1.5A output -30°C~+70°C Perfect with PFA12X series(IP66)	AC180~264V input DC12V, 2A output -30°C~+70°C Structural water-proof	Line-Interactive 600VA/360W 2-6ms transfer time	Line-Interactive 1500VA/900W 2-6ms transfer time	Smart Online 1000VA/900W 0ms transfer time





Distributed Power Supplies		Switching Power Supplies		Cables				
Model	PFM34x Series		Switching Power Supply		PFM930-59N	PFM930I-6N	PFM940I-59N/2	PFM940I-6N/2
Appearance								
Description	5/9 Channel AC90~264V input DC12V, 4A/5A output	9/19 Channel AC90~264V input DC12V, 10A/20A output	AC90~264V input DC12V, 50W output 98x98x38mm (3.86"x3.86"x1.5")	AC90~132V/180~264V input DC12V, 150W output 178x97x38mm (7.01"x3.82"x1.5")	RG59 Coaxial Cable Conductor: OFC Jacket: PVC, 6.1mm, Color: black Length: 200m(656.2ft)	RG6 Coaxial Cable Conductor: OFC Jacket PVC: 6.9mm Color: black Length: 200(656.2ft)	RG59 Siamese Cable Conductor: OFC Jacket PVC: 6.1mm Power Conductor: 0.5mm ² Color: black Length: 200(656.2ft)	RG6 Siamese Cable Conductor: OFC Jacket PVC: 6.9mm Power Conductor: 0.75mm ² Color: black Length: 200(656.2ft)

Cabinets							
Model	PFC200-6U4D/6U6D	PFC200-12U6D/12U8D	PFC610	PDU	Fan	Caster Wheel	PFM700-E
Appearance							
Description	19" 6U Rack Cabinet Supports wall & plane mount Depth:450mm/600mm(17.72"/23.62") Total load bearing: 40kg(88.18lb) Shaft load bearing: 40kg(88.18lb)	19" 12U Rack Cabinet Supports wall & plane mount Depth:450mm/600mm(23.62"/3.94") Total load bearing: 80kg(176.37lb) Shaft load bearing: 40kg(88.18lb)	19" Rackmount Tray Load bearing: 40kg(88.18lb)	8 Outlet Rackmount PDU Power Strip	Rackmount Cooling Fan Support up to 2 fans to be mounted to one rack cabinet	Caster Wheel Frame material: steel&PU Each load bearing: 60kg(132.3lb)	HDMI Extender DC5V for transmitter 1080P/60m Transmitter: 1 in/2 out Receiver: 1 out

ACCESSORIES

Baluns				PoC	Isolators	
Model	PFM800-4MP	PFM801-4MP	PFM809-4MP	PFM811-C/4CH	PFM790	PFM791
Appearance						
Description	Passive HDCVI Balun Transmission distance: 4MP: max.200m(656.17ft) Cable type: CAT 5E/6 (R<10Ω/100m)	Passive HDCVI Balun With Power Input: DC24-36V Output: max.DC12V 8W Transmission distance: 4MP: max.200m(656.17ft) Cable type: CAT 5E/6 (R<10Ω/100m)	16Channel Passive HDCVI Balun Receiver Transmission distance: 4MP: max.200m(656.17ft) (with passive transmitter) Cable type: CAT 5E/6 (R<10Ω/100m)	POC Transceiver Input: DC12V-36V Output: max.DC12V 15.6W Transmission distance: max.400m(1312.3ft) Cable type: RG59/6	Power Isolator Effectively solve image problems caused by centralized power supply	HD Video Isolator Effectively solve image problems caused by ground loops.

Optical Transceivers				
Model	OTC102T/R	PFO2410T/R	PFO2810T/R	PFO2910T/R
Appearance				
Description	1ch HDCVI Optical Transceiver Lossless non-compression real-time transmission FC, Single-mode, 20km Supports 720P/1080P	4ch HDCVI Optical Transceiver Lossless non-compression real-time transmission FC, Single-mode, 20km Supports 720P/1080P	8ch HDCVI Optical Transceiver Lossless non-compression real-time transmission FC, Single-mode, 20km Supports 720P/1080P	16ch HDCVI Optical Transceiver Lossless non-compression real-time transmission LC, Single-mode, 20km Supports 720P/1080P

Converters		Distributors		
Model	TP2105	PFT2100	TP2600	PFT2690
Appearance				
Description	Input :720P/1080P HDCVI signal Output: HDCVI, HDMI, VGA, CVBS Supports RS485 to control PTZ	Input :HDMI video signal Output: HDCVI signal	1 in/3 out 720P/1080P self-adaptive Works as a repeater to increase the transmission distance	16-ch HDCVI input, 32-ch output, each input is corresponding to 2 outputs 720P/1080P self-adaptive Compatible CVBS, AHD, HDTVI signal distribution

DISPLAY & CONTROL

Monitors			Decoders		KVM		Keyboards	
	LM18-L100	LM22-L200		NVD0405DH-4K		KVM0801HM-E100		NKB5000
Model			Model		Model		Model	
Diagonal	18.5"(16:9)	21.5"(16:9)	Supported Screen	4 Screens Splicing Control	System	DOS, WIN3.X, WIN95/98/98SE/2000/ME/ XP/7/8/10, WinNT, UNIX/LINUX	Operation System	Embedded LINUX 4.2.0
Resolution	1366x768	1920x1080	Split Mode	1/4/9/16 4CH@12MP(15fps)/ 4CH@4K/16CH@1080P/ 36CH@720P/64CH@D1	Computer Connections	8	Audio Input/ Output	1 pair 3.5mm jack, supported bidirectional talk
Luminance	200cd/m ²	200cd/m ²	Local Video Input	1CH HDMI Network Video Input	Port Selection	Hotkeys, buttons	Loudspeaker	1
Contrast	600:1	1000:1	Video Output	HDMI/VGA/BNC Audio Out	Console Ports	2 USB for Keyboard/Mouse, 1 HDMI for Video	Alarm In	4, High-low level
Viewing Angle	H 178°, V 178°	H 170°, V 160°	Alarm In/Out	4/4(30VDC 1A, 125VAC 0.5A, Relay output) Intercom	KVM Ports	8 Keyboard/Mouse, 8 Video, 8 USB	Alarm Out	4 (3 relay, 1 12V_1A)
Response Time	5ms	5ms	Processor	Dual-core embedded microprocessor Case	Cable Length	4x1.5m, 4x1.8m	Stream Type	H.265, H.264, MPEG, Nonstandard
Gamut	0.72(CIE1931)	0.72(CIE1931)	Ethernet	1 RJ-45 port(10/100/1000M) USB	Video	1920x1440, 1080P	Resolution	4CH@4K/16CH@1080P
Display Color	8bit	8bit	Power Supply	DC12V/3.3A Control Mode	Scan Interval	3- 99 seconds adjusting	Display split	1/4/9/16
Input	1 VGA, 1 HDMI 1 BNC, 1 Audio	1HD(supported HDCVI, TVI, AHD, CVBS), 1 VGA, 1 HDMI 1 BNC, 1 Audio	Highlights	4K & H.265 decoding, Fisheye adjustment	Power Supply	DC12V 500mA	Screen	10.1" TFT LCD touch screen (1280x800)
Output	2 Speakers, 1 BNC	2 Speakers, 1 HD			Power Consumption	≤2W	Joystick	4-axis(zoom, focus, iris)
Control	Physical Button	Physical Button			Working Temperature	-45°C~+65°C	Control Mode	Direct Mode, Network Mode
Working Temperature	0°C~+40°C (+32°F~+104°F)	0°C~+40°C (+32°F~+104°F)			Working Humidity	10% ~ 80%, Non-condensing	USB Interface	2 USB3.0 + 2 USB2.0
Working Humidity	10~85%	10~85%			Unit Dimension	136.5mmx430.8x45.5mm (WxLxH)	Power	DC12V, 4A
Power	AC100~240V(+/-10%), 20W	AC100~240V(+/-10%), 30W			Weight	1.28Kg	Working Temperature	-10°C ~+55°C
Dimensions	442.0x276.0x51.5mm (17.4"x10.9"x2.0")	516.6x316.7x51.2mm (20.3"x12.5"x2.0")					Working Humidity	10%~95%
Weight	2.8kg(6.2lb)	3.8 kg(8.4lb)					Dimension	Host: 425x194x59mm (WxDxH) (height: exclude joystick) Mini Keyboard: 421x105x26mm (WxDxH)
							Weight	<3.73kg (exclude package)

VIDEO MANAGEMENT SOFTWARE

Smart PSS

Smart Professional Surveillance System

Dahua Security Management Platform



DMSS

Digital Mobile Surveillance System

Monitor Anything with Your SmartPhone or Tablet Anytime, Anywhere



Supported OS	Windows/Mac OSX
Supported Devices	IPC, NVR, DVR, CVR, VTO, ASC, ASA, NKB, M70 etc.
Number of Devices	64
Number of Channels	256
Number of Screens	4
Recording Channels	32
Languages	35
Supported VTO	64
Supported VTH	256
Supported Access Controllers	64
Supported Doors	1000
Basic Functions	Preview, Record, Playback, Export, Snapshot, Instant playback
Smart Features	Fisheye correction, People counting, Smart search, E-Map, E-PTZ, Smart Track, IVS, Face Detection
Smart Building	Video Intercom, Access Control, Attendance

Devices	Supported Devices	DVR, NVR, IPC, VTO, Alarm
	Add Device Method	Initialization, IP/domain, SN, IMPort from cloud
	Features	Remote config, Alarm config, HDD info, Share device list
Video	Compression Format	H.265/H.264/MPEG-4/JPEG
	Display Resolution	Up to 1920 x 1080
Live Preview	Max. Channels Can Be Opened at The Same Time	256
	Features	Snapshot, Record, Instant playback, PTZ, Stream control, Talk, Audio, Alarm, Color, Favorites, Remember channels
Playback	Time Period of Video Playback	72 hours
	Features	Snapshot, Record, Faster/slower play, Play next frame, Cut
Alarm Push	Alarm Type	Motion detect, Camera masking, Local alarm, Disk alarm(no disk, Low space, disk Error), Face detection, Ivs alarm
	Push Type	Video, Preview, Image

VIDEO MANAGEMENT SOFTWARE

Easy4ip Cloud

The most user-friendly cloud surveillance platform

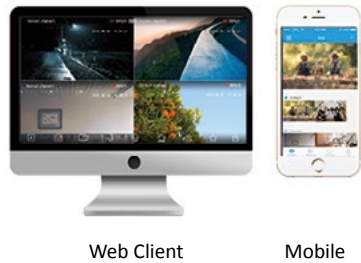

Easy4ip is a cloud computing-based video management platform. Easy4ip connects millions of devices, including cameras, doorbells, alarms, etc., over a single global cloud network. It is widely used in video surveillance, smart home, smart building, and education applications. Easy4ip supports multiple services, such as live streaming, broadcasting, video on demand, cloud storage, cloud-based device upgrade, alarm notifications, video analytics, etc. Easy4ip is also an open system which features SDKs for device developers and system integrators to create their own video systems.



Remote Live Streaming
Monitor anytime, anywhere from your mobile device or PC



Cloud Upgrade
Upgrade device firmware remotely, keeping devices up-to-date



Cloud Storage
Alarm video is stored in the cloud, ensuring you don't miss a thing



Alarm Notifications
Stay informed of what's happening in your home or at the store while on the go



Global Server Network
Hybrid cloud includes Amazon, Azure, and other server providers, guaranteeing speed and stability



Security
Several security policies to secure your personal data

DORI Distance (D/O/R/I)

Find the Optimal Camera for Your Individual Surveillance Needs

The DORI distance is a “general proximity” of distance which makes it easy to pinpoint the right camera for your needs. The DORI distance is calculated based on sensor specification and lab test result according to EN 62676-4 which defines the criteria for Detect, Observe, Recognize and Identify respectively.

- Detect: 25ppm
- Observe: 63ppm
- Recognize: 125ppm
- Identify: 250ppm

HDCVI CAMERA

Ultra Series

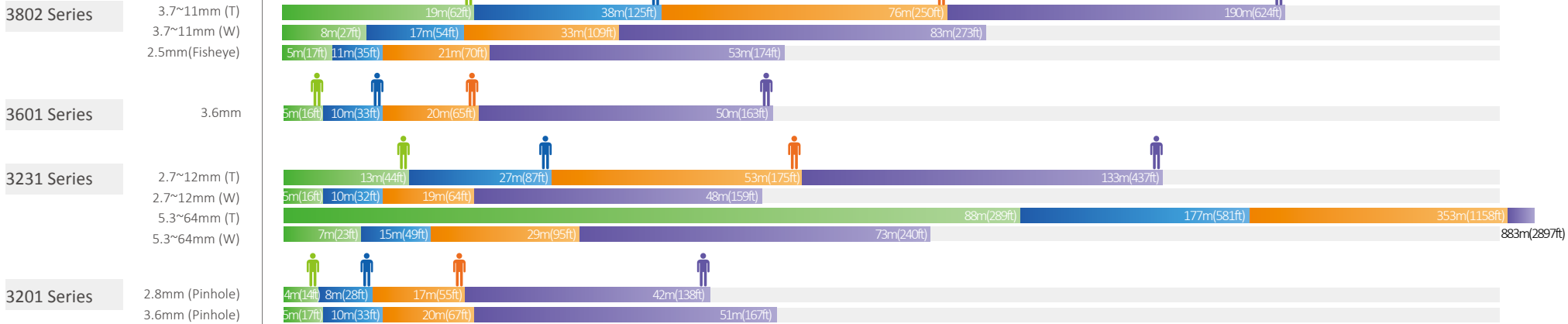

Pro Series

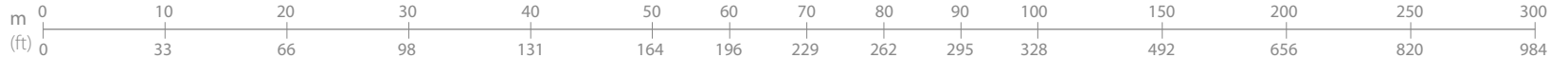

DORI Distance (D/O/R/I)

2401 Series

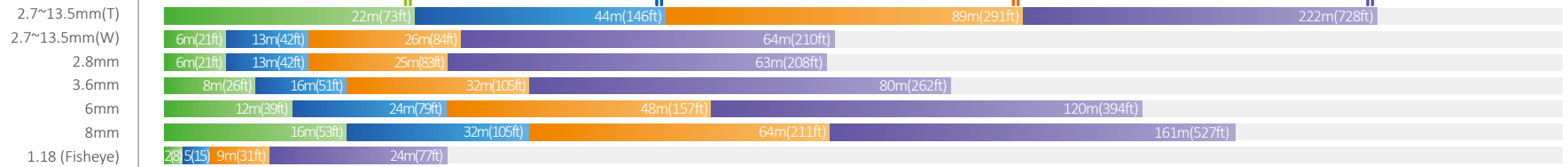

2241 Series

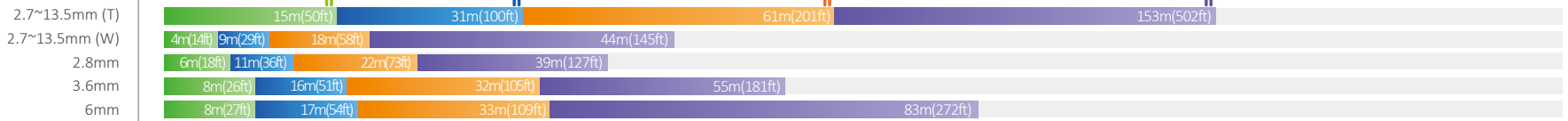

2249 Series

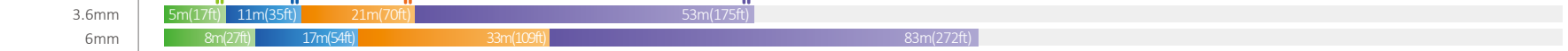

2231 Series

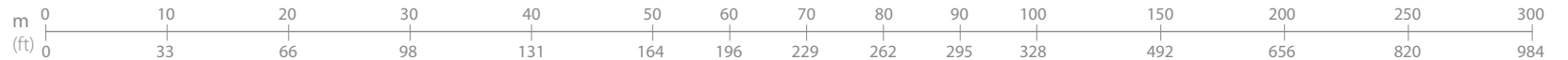

Lite Series

1400 Series

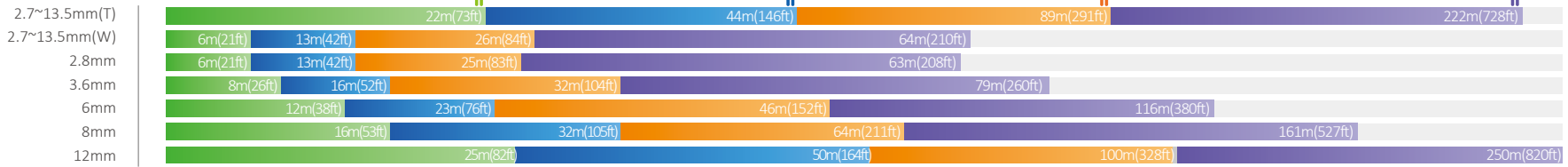

DORI Distance (D/O/R/I)

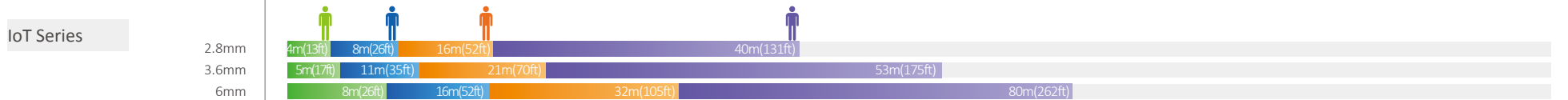
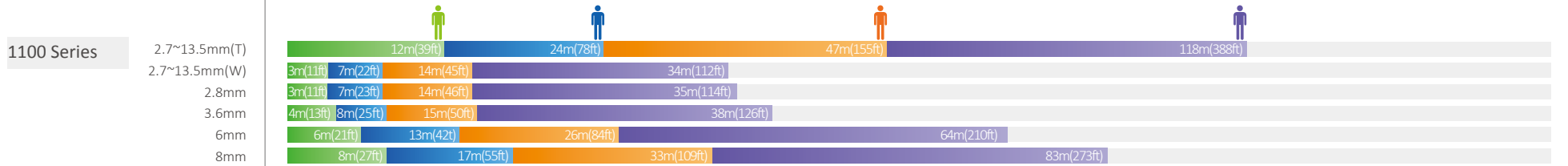
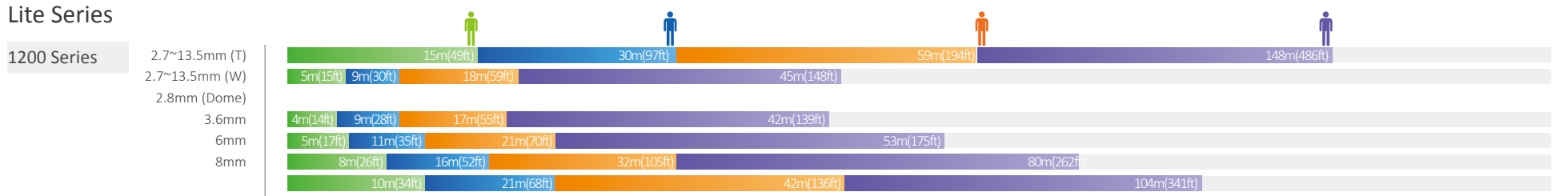
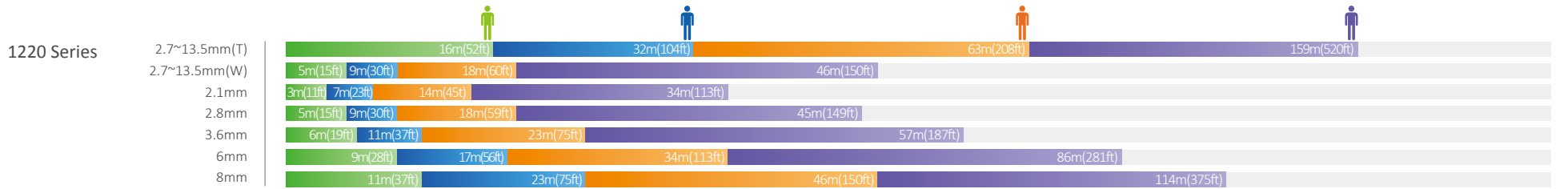

DORI Distance (D/O/R/I)

HDCVI PTZ CAMERA

Ultra Series

SD6AE/65F230IA-HC

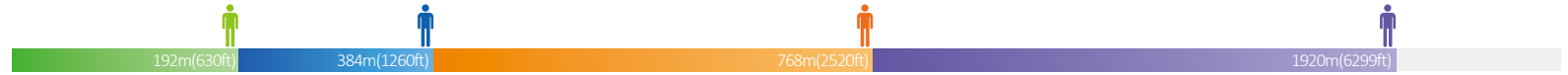

Pro Series

SD6C/60/59/50/52C430I-HC



SD6C/60/59/50/52C230I-HC

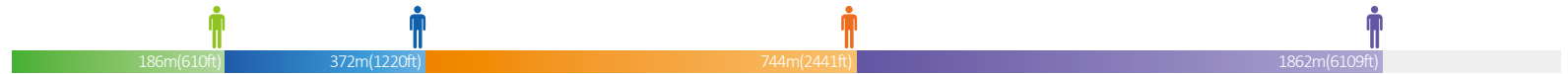

SD6C/60/59/50/52C225I-HC
SD6C/60/59/50/52C131I-HC



Lite Series

SD49225I-HC, SD49131I-HC



SD49/40/42/42C212I-HC
SD49/40/42/42C116I-HC



SD22204I-GC

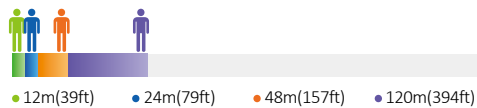

ENABLING A SAFER SOCIETY AND SMARTER LIVING

Dahua Mexico

Tel: +52 55 67231936
Email: sales.mx@global.dahuatech.com

Dahua Brazil

Tel: +55 11 32511871
Email: comercial.br@global.dahuatech.com

Dahua Thailand

Tel: +66 29382674
Email: info.th@global.dahuatech.com
hr.th@global.dahuatech.com

Dahua S.Korea

Tel: +82 7081618889
Email: DH-KOREA@global.dahuatech.com

Dahua Singapore

Tel: +65 65380952
Email: info.sg@global.dahuatech.com

Dahua Turkey

Email: sales.tr@global.dahuatech.com

Dahua Indonesia

Email: support.id@global.dahuatech.com
sales.id@global.dahuatech.com

Dahua Malaysia

Tel: +60376620731
Email: sales.mas@global.dahuatech.com

Dahua India

Tel: +91 1244569100
Email: sales.india@global.dahuatech.com

Dahua Russia

Tel: 8 (499) 682-60-00
Email: info@global.dahuatech.com

Dahua Kazakhstan

Tel: +7 727 3110838

Dahua UK

Tel: +44(0)1628 673 667
Email: sales.UK@global.dahuatech.com

Dahua Netherlands

Tel: +31 (0) 79 799 96 96
Email: sales.benelux@global.dahuatech.com

Dahua France

Email: sales.france@global.dahuatech.com

Dahua Iberia

Tel: +34 917649862
Email: sales.iberia@global.dahuatech.com

Dahua Italy

Tel: +39 3703446609
Email: sales.italy@global.dahuatech.com

Dahua Germany

Tel: +49 211 20544121
Email: sales.de@global.dahuatech.com

Dahua CEE & Nordic

Tel: +48 223957400
Email: biuro.pl@global.dahuatech.com

Dahua S. Africa

Email: Dahua.sa@global.dahuatech.com

Dahua Australia

Tel: +61 299285200
Email: sales.oc@global.dahuatech.com

Dahua Middle East

Tel: +971 48815300
Email: sales.me@global.dahuatech.com

* Design and specifications are subject to change without notice.

HDCVI Product Selection V2-01, Apr 2018



DAHUA TECHNOLOGY

No.1199 Bin'an Road, Binjiang District, Hangzhou, China. 310053
Tel: +86-571-87688883 Fax: +86-571-87688815
Email: overseas@dahuatech.com
www.dahuasecurity.com



© Dahua Technology, All rights reserved